

PHARMA HEALTH
PHARMA MACHINES/DEVICES
HEALTH & BEAUTY
ENGINEERING PHARMA

SOLUCIONES
ESPECÍFICAS PARA
APLICACIONES
ESPECÍFICAS



accesfluid

Soluciones Técnicas Conducción de Fluidos y Aire Comprimido

 Sang-A M CPC ESG Danfoss Hansen LUDECKE EATON
Powering Business Worldwide

Especialistas y Marcas de Prestigio

Una larga trayectoria como especialistas en la conducción de fluidos nos respalda, motiva y posiciona en el mercado español como un serio referente en sectores como la industria química, farmacéutica, petróleo y gas, alimentación e ingeniería. Nuestro esfuerzo de años se ha visto reconocido a través de nuestras marcas representadas de prestigio internacional.

Asesoramiento y Servicio

En ACCESFLUID disponemos de un departamento técnico especializado donde pueden ayudarle a encontrar la mejor solución, siempre personalizada con una respuesta rápida y rentable.

Nuestro objetivo se basa en un continuo proceso de investigación y desarrollo de productos innovadores que cubren las necesidades reales de nuestros clientes.

Innovación y Calidad

Todos los artículos de nuestro programa son de máxima calidad, que disponen como mínimo del certificado ISO 9001/2000.

Ponemos dichos certificados a su disposición en caso de requerimiento, así como certificaciones específicas sobre productos concretos.

 CERTIFICACIÓN FDA NSF USP ATEX OSHA ADI ROHS COMPLIANT 2002/95/EC

Pre

Junt
proporci





Preparados para aportar las mejores soluciones a sus más exigentes requerimientos

Con nuestra experiencia técnica y nuestro extenso programa, estamos estratégicamente posicionados para proporcionar los productos y la experiencia que necesita, cuando los necesita. Trabajamos con usted para comprender los desafíos de su aplicación y desarrollar soluciones efectivas para obtener el mejor resultado.

PHARMA HEALTH

Fabricantes de medicamentos
Laboratorios

PHARMA MACHINES/DEVICES

Fabricantes de maquinaria para la Industria Farmacéutica
Fabricantes de dispositivos para laboratorio

HEALTH & BEAUTY

Fabricantes de productos para la salud y belleza

ENGINEERING PHARMA

Ingenierías de instalaciones para la Industria Farmacéutica

Índice



pág.
6

IMAFLW®
TUBO SILICONA TRANSPARENTE
PLATINUM CURED "STANDARD GRADE"



pág.
7

IMAPURE®
TUBO SILICONA TRANSPARENTE
PLATINUM CURED "ADVANCED GRADE"



pág.
8

IMAFIT®
MANGUERA REFORZADA SILICONA
SANITARIA PLATINUM CURED



pág.
9

IMAVAC®
MANGUERA REFORZADA CON ESPIRAL SS316
SILICONA SANITARIA PLATINUM CURED



pág.
10

TUBO FLUOROPOLÍMERO FEP



pág.
10

TUBO FLUOROPOLÍMERO PFA

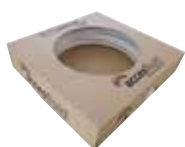

pág.
11

TUBO TEFLÓN CALIBRADO PTFE
NATURAL



pág.
12

TUBO PVDF
TUBO TERMOPLÁSTICO DE PVDF
(POLIFLUORURO DE VINILIDENO)



pág.
12

IMAWELD®
TUBO TERMOPLÁSTICO ELASTÓMERO
CON SELLADO POR CALOR Y PROPIEDADES DE
SOLDADURA



pág.
13-14

IMALINK®
CONDUCCIÓN TÉCNICA PERSONALIZADA
PARA PHARMA "SINGLE USE"



pág.
15

IMALOK®
ACCESORIOS



pág.
16-21

RACORES INSTANTÁNEOS
EN ACERO INOX 316L



pág.
22-25

RACORES RÁPIDOS
EN ACERO INOX 316L



pág.
26-30

RACORES RÁPIDOS EN PFA



pág.
31-32

VÁLVULAS DE CONTROL EN PFA



pág.
33-35

CLEAN FITTING



pág.
36

RACORES POLIPROPILENO
FITQUIK™



pág.
37

ENCHUFE RÁPIDO INOX
MINIATURA DN 5 CON DOBLE VÁL-
VULA (OPCIONAL SIMPLE VÁLVULA)



pág.
38

ENCHUFE RÁPIDO INOX
DN 7.2 CON DOBLE Y SIMPLE VÁLVULA



pág.
39

ENCHUFE RÁPIDO INOX
SERIE MLDB SISTEMA ANTIGOTEO "BAJA
PRESIÓN"



pág.
39

ENCHUFE RÁPIDO ACERO INOX AISI 316 SE-
RIE MLFF SISTEMA ANTIGOTEO "FLAT FACE"



pág.
40

ENCHUFE RÁPIDO ACERO
SERIE FF SISTEMA ANTIGOTEO "FLAT FACE"



pág.
41-42

RACORES TRI-CLAMP
DIN 32676



pág.
43-46

RACORES DIN 11851



pág.
47-48

VÁLVULAS DE DIAFRAGMA



pág.
49

VÁLVULAS DE DIAFRAGMA
CON CONTROL PROPORCIONAL
NEUMÁTICO



pág.
50

REGULADORES DE CAUDAL INOX



pág.
51

REGULADOR DE PRESIÓN MEDIA
INOX 316 (AIRE/GAS TÉCNICO/LÍQUIDO)



pág.
52

GAMA COMPLETA DE FILTRACIÓN EATON

CONECTANDO SOLUCIONES



- . TUBOS TÉCNICOS
- . MANGUERA INDUSTRIAL
- . MANGUERA COMPOSITE
- . TUBOS METÁLICOS FLEXIBLES



Soluciones personalizadas. Diseño y producción integral.
Amplia gama de conexiones. Mangueras de \varnothing 3/4" a 6"
Pruebas de hidrostática, elongación y conductividad.
Posibilidad de emisión de certificado, marcaje y personalización.
Pruebas "in situ".

SECTORES Y APLICACIONES

Diseñamos y producimos íntegramente conexiones con una amplia gama de tubos, mangueras y conductos flexibles junto con racores y accesorios con máximas exigencias de calidad.
Accesfluid, como distribuidor y fabricante de productos destinados al sector industrial: racores, tuberías y mangueras, válvulas, enchufes rápidos, instrumentación, filtración, etc. está presente en sectores tan exigentes como la industria química, farmacéutica, petróleo y gas, alimentación, ingeniería; mejorando los procesos de trabajo, la calidad y la seguridad en todo tipo de aplicaciones y entornos diversos.

Disponemos de prensas con capacidad para prensar mangueras de \varnothing 3/4" hasta 6"





IMAFLOW®

TUBO SILICONA TRANSPARENTE PLATINUM CURED "STANDARD GRADE"



Rollo de 10 m.

CARACTERÍSTICAS:

La tubería de silicona curada "Platinum" IMAFLOW®, está fabricada y embalada en ambiente libre de suciedad en instalaciones certificadas ISO 9001 QMS - ISO 14001 & OHSAS 18001. El proceso de fabricación cumple los estándares de calidad.

- . Materia prima 100% Silicona Platinum Grado Standard. Mejor transparencia y calidad de transferencia de fluidos que la silicona peróxido.
- . Dureza: 60° shore A (otras durezas bajo pedido).

APLICACIONES:

- . Industria Farmacéutica.
- . Química general.
- . Industria Alimentaria.
- . Máquinas Vending.
- . Cosmética.
- . Bombas peristálticas.
- . Esterilizable por vapor, calor seco, óxido de etileno y radiación gamma.



CERTIFICACIONES:

- . USP Class VI.
- . FDA 21 CFR 177.2600.
- . Phthalate/Bis-phenol Free COA.
- . TSE/BSE.
- . ROHS.
- . Ciclos de esterilización: 20.



BAJO PEDIDO,
POSIBILIDAD MARCAJE
LÍNEA DE COLOR EN EL TUBO
PARA DIFERENCIAR APLICACIONES



IMAFLOW™

Ref.	Código	Dimensiones				Grosor		
		pack 10 m	Ø int. (inch)	Ø int. (mm)	Ø ext. (inch)	Ø ext. (mm)	(inch)	(mm)
701-203-60	0606706710089		1/16"	1,60	1/8"	3,17	1/32"	0,80
701-115-60	0606706710062		5/64"	2,00	13/64"	5,00	1/16"	1,50
701-117-60	0606706710063		1/8"	3,00	1/4"	6,00	1/16"	1,50
701-205-60	0606706710091		1/8"	3,00	5/16"	8,00	2,32	2,50
701-204-60	0606706710090		1/8"	3,17	1/4"	6,35	1/16"	1,50
701-119-60	0606706710064		5/32"	4,00	1/4"	6,00	3/64"	1,00
701-121-60	0606706710065		5/32"	4,00	5/16"	8,00	5/64"	2,00
701-122-60	0606706710067		3/16"	4,76	5/16"	7,90	1/16"	1,50
701-123-60	0606706710068		3/16"	4,76	3/8"	9,50	3/32"	2,50
701-125-60	0606706710069		13/64"	5,00	5/16"	8,00	1/16"	1,50
701-126-60	0606706710070		13/64"	5,00	23/64"	9,00	5/64"	2,00
701-127-60	0606706710071		13/64"	5,00	25/64"	10,00	3/32"	2,50
701-129-60	0606706710072		15/64"	6,00	5/16"	8,00	3/64"	1,00
701-130-60	0606706710073		15/64"	6,00	23/64"	9,00	1/16"	1,50
701-131-60	0606706710074		15/64"	6,00	25/64"	10,00	5/64"	2,00
701-133-60	0606706710075		15/64"	6,00	15/32"	12,00	1/8"	3,00
701-171-60	0606706710083		1/4"	6,35	3/8"	9,50	1/16"	1,50
701-208-60	0606706710092		1/4"	6,35	7/16"	11,11	3/32"	2,50
701-209-60	0606706710093		1/4"	6,35	1/2"	12,70	1/8"	3,00
701-140-60	0606706710076		5/16"	8,00	15/32"	12,00	5/64"	2,00
701-141-60	0606706710077		5/16"	8,00	35/64"	14,00	1/8"	3,00
701-146-60	0606706710078		23/64"	9,00	5/8"	16,00	9/64"	3,50
701-177B-60	0606706710085		3/8"	9,50	1/2"	12,70	1/16"	1,50
701-149-60	0606706710079		25/64"	10,00	35/64"	14,00	5/64"	2,00
701-150-60	0606706710080		25/64"	10,00	5/8"	16,00	1/8"	3,00
701-210-60	0606706710094		25/64"	10,00	45/64"	18,00	5/32"	4,00
701-153-60	0606706710081		15/32"	12,00	25/32"	20,00	5/32"	4,00
701-173-60	0606706710084		1/2"	12,70	3/4"	19,05	1/8"	3,00
701-196-60	0606706710087		1/2"	12,70	1"	25,40	1/4"	6,35
701-212-60	0606706710095		5/8"	16,00	15/16"	24,00	5/32"	4,00
701-160B-60	-		3/4"	19,05	1"	25,40	1/8"	3,00
701-188-60	-		63/64"	25,00	1-3/8"	35,00	13/64"	5,00
701-202-60	0606706710088		1"	25,40	1-1/2"	38,10	1/4"	6,35



IMAPURE®

TUBO SILICONA TRANSPARENTE PLATINUM CURED "ADVANCED GRADE"



CARACTERÍSTICAS:

La tubería de silicona curada "Platinum" IMAPURE®, está fabricada en sala blanca con los más estrictos estándares de calidad. Materia prima 100% Silicona Platinum Grado Avanzado pura manipulada por maquinaria de alta tecnología y precisión con el más exigente control del proceso.

Esta manguera cumple todas las certificaciones exigidas en los procesos más críticos de distintos sectores.

Disponible versión montada con diferentes gamas de racores en uno o ambos extremos.

- . Dureza: 60° shore A (otras durezas bajo pedido).

APLICACIONES:

- . Industria Farmacéutica.
- . Biotecnología.
- . Inyectables.
- . Cosmética.
- . Industria Alimentaria.
- . Bombas peristálticas.
- . Esterilizable por vapor, calor seco, óxido de etileno y radiación gamma.

CERTIFICACIONES:

- . USP Class VI.
- . FDA 21 CFR 177.2600.
- . NSF - 51.
- . ISO 10933.
- . US-FDA (DFM #26201).
- . European Pharmacopoeia 3.1.9 para siliconas.
- . Phatalate/Bis-phenol Free COA.
- . TSE/BSE.
- . German BfRxv.
- . ROHS.
- . France Arrete du 25.
- . Certificado de laboratorio.
- . De Conformidad.
- . Fabricado y embalado en sala blanca certificada ISO (Class 7).
- . Ciclos de esterilización: 25.

* Datos de extraíbles disponibles bajo petición.



BAJO PEDIDO,
POSIBILIDAD MARCAJE
LÍNEA DE COLOR EN EL TUBO
PARA DIFERENCIAR APLICACIONES

Ref.	Código	Dimensiones				Grosor		
		pack 10 m	Ø int. (inch)	Ø int. (mm)	Ø ext. (inch)	Ø ext. (mm)	(inch)	(mm)
901-203-60	0606706710168		1/16"	1,60	1/8"	3,17	1/32"	0,80
901-115-60	0606706710138		5/64"	2,00	13/64"	5,00	1/16"	1,50
901-117-60	0606706710139		1/8"	3,00	1/4"	6,00	1/16"	1,50
901-205-60	0606706710170		1/8"	3,00	5/16"	8,00	2,32	2,50
901-204-60	0606706710169		1/8"	3,17	1/4"	6,35	1/16"	1,50
901-119-60	0606706710141		5/32"	4,00	1/4"	6,00	3/64"	1,00
901-121-60	0606706710142		5/32"	4,00	5/16"	8,00	5/64"	2,00
901-122-60	0606706710144		3/16"	4,76	5/16"	7,90	1/16"	1,50
901-123-60	0606706710145		3/16"	4,76	3/8"	9,50	3/32"	2,50
901-125-60	0606706710146		13/64"	5,00	5/16"	8,00	1/16"	1,50
901-126-60	0606706710147		13/64"	5,00	23/64"	9,00	5/64"	2,00
901-127-60	0606706710148		13/64"	5,00	25/64"	10,00	3/32"	2,50
901-129-60	0606706710149		15/64"	6,00	5/16"	8,00	3/64"	1,00
901-130-60	0606706710150		15/64"	6,00	23/64"	9,00	1/16"	1,50
901-131-60	0606706710151		15/64"	6,00	25/64"	10,00	5/64"	2,00
901-133-60	0606706710153		15/64"	6,00	15/32"	12,00	1/8"	3,00
901-171-60	0606706710162		1/4"	6,35	3/8"	9,50	1/16"	1,50
901-208-60	0606706710171		1/4"	6,35	7/16"	11,11	3/32"	2,50
901-209-60	0606706710172		1/4"	6,35	1/2"	12,70	1/8"	3,00
901-140-60	0606706710154		5/16"	8,00	15/32"	12,00	5/64"	2,00
901-141-60	0606706710155		5/16"	8,00	35/64"	14,00	1/8"	3,00
901-146-60	0606706710156		23/64"	9,00	5/8"	16,00	9/64"	3,50
901-177B-60	0606706710164		3/8"	9,50	1/2"	12,70	1/16"	1,50
901-149-60	0606706710157		25/64"	10,00	35/64"	14,00	5/64"	2,00
901-150-60	0606706710158		25/64"	10,00	5/8"	16,00	1/8"	3,00
901-210-60	0606706710173		25/64"	10,00	45/64"	18,00	5/32"	4,00
901-153-60	0606706710159		15/32"	12,00	25/32"	20,00	5/32"	4,00
901-173-60	-		1/2"	12,70	3/4"	19,05	1/8"	3,00
901-196-60	0606706710166		1/2"	12,70	1"	25,40	1/4"	6,35
901-212-60	0606706710174		5/8"	16,00	15/16"	24,00	5/32"	4,00
901-160B-60	-		3/4"	19,05	1"	25,40	1/8"	3,00
901-188-60	-		63/64"	25,00	1-3/8"	35,00	13/64"	5,00
901-202-60	0606706710167		1"	25,40	1-1/2"	38,10	1/4"	6,35



IMAPURE™



IMAFIT®

MANGUERA REFORZADA SILICONA SANITARIA PLATINUM CURED



CARACTERÍSTICAS:

- Nuestra manguera de silicona reforzada curada "Platinum", está fabricada en sala blanca con los más estrictos estándares de calidad.
- Materia prima 100% silicona pura manipulada por maquinaria de alta tecnología y precisión con el más exigente control del proceso.
- Refuerzo en poliéster (Nylon bajo pedido).
- Esta manguera cumple todas las certificaciones exigidas en los procesos más críticos de distintos sectores.
- Disponible versión montada con diferentes gamas de racores en uno o ambos extremos.

CERTIFICACIONES:

- USP Class VI.
- US-FDA 21 CFR 117.2600.
- NSF - 51.
- ISO 10933-1.
- PHthalate - BISPHENOL FREE.
- TSE/BSE.
- ROHS.

APLICACIONES:

- Industria Farmacéutica.
- Biotecnología.
- Cultivo y carga de células.
- Cosmética.
- Industria Alimentaria.
- Análítica Laboratorios.

Rollo de 5 m.

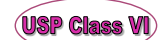

Temperatura servicio

-80°C a +180°C



BAJO PEDIDO,
POSIBILIDAD DE MARCAJE
LÍNEA DE COLOR IDENTIFICATIVA CON
MATERIA PRIMA DE SILICONA

IMAFIT™

Ref.	Código	Dimensiones en mm		Dimensiones en pulgadas	Espesor pared	Presión trabajo	Radio curvatura mínima	Longitud rollos
		ID	OD	ID				
	pack 5 m				mm	bar	mm	mts*
0613FT	0606706710005	6	13	1/4"	3,5	10	50	5
0916FT	0606706710007	9	16	11/32"	3,5	9	50	5
1220FT	0606706710010	12	20	1/2"	4	7	80	5
1624FT	0606706710012	16	24	5/8"	4	7	90	5
1927FT	0606706710014	19	27	3/4"	4	6	110	5
2535FT	0606706710017	25	35	1"	5	4	160	5
3242FT	0606706710021	32	42	1-1/4"	5	3	200	5
3747FT	0606706710023	37	47	1-1/2"	5	2,5	250	5
5062FT	-	50	62	2"	5	2	320	5



IMAVAC® MANGUERA REFORZADA CON ESPIRAL SS316 SILICONA SANITARIA PLATINUM CURED



CARACTERÍSTICAS:

- Nuestra manguera de silicona reforzada curada "Platinum", está fabricada en sala blanca con los más estrictos estándares de calidad.
- Cumple todas las certificaciones exigidas en los procesos más críticos de distintos sectores.
- . Materia prima 100% silicona pura manipulada por maquinaria de alta tecnología y precisión con el más exigente control del proceso.
 - . Disponible versión montada con diferentes gamas de racores en uno o ambos extremos de distintos sectores.
 - . Dispone de un refuerzo en Inox316.
 - . Propiedades antiestáticas.



Temperatura servicio
-80°C a +180°C

CERTIFICACIONES:

- . USP Class VI.
- . ISO 10933 - 1.
- . NSF - 51.
- . US - FDA 21 CFR 177.2600.
- . PHTHALATE - BISPENOL FREE.
- . TSE/BSE.
- . ROHS.

APLICACIONES:

- . Alto vacío.
- . Industria Farmacéutica.
- . Biotecnología.
- . Cultivo y cargas de células.
- . Cosmética.
- . Industria Alimentaria.
- . Analítica Laboratorios.
- . Aplicaciones antiestáticas.



IMAVAC®

Ref.	Código	Dimensiones en mm		Dimensiones en pulgadas	Espesor pared	Presión trabajo	Radio curvatura mínima	Vacío A 27°C	Longitud rollos
		ID	OD	ID			mm		
0613VC	0606706710006	6	13	1/4"	3,5	12	50	760	5
0916VC	0606706710008	9	16	11/32"	3,5	11,5	60	760	5
1220VC	0606706710011	12	20	1/2"	4	10,5	70	760	5
1624VC	0606706710013	16	24	5/8"	4	10	80	760	5
1927VC	0606706710016	19	27	3/4"	4	8,5	90	760	5
2535VC	0606706710020	25	35	1"	5	8,5	125	760	5
3242VC	0606706710022	32	42	1-1/4"	5	8	140	600	5
3747VC	0606706710024	37	47	1-1/2"	5	7,5	170	600	5
5062VC	0606706710060	50	62	2"	5	6	240	550	5
6476VC	0606706710061	64	76	2-1/2"	4	4	330	500	5
7587VC	0606706710097	75	87	3"	3	3	420	400	5
100112VC	0606706710001	100	112	4"	2	2	550	400	5

* Otras longitudes de rollo disponibles bajo pedido.

TUBO FLUOROPOLÍMERO FEP



CARACTERÍSTICAS:

- . Tubo FEP excelente compatibilidad química.
- . Extremadamente estable a los rayos UV.
- . Buenos valores dieléctricos.
- . Alta transparencia óptica.
- . Alta resistencia a bajas temperaturas.

COLOR:

- . Translúcido.

CERTIFICACIONES:

- . Ignífugo según UL 94 VO.
- . Aprobación FDA.

APLICACIONES:

- . Industria química.
- . Industria médica y farmacéutica.
- . Salas blancas.
- . Sector agroalimentario.
- . Electrónica, electricidad y semiconductores.
- . Gases.
- . Aplicaciones con alta exigencia de vida útil.
- . Indicadores de nivel.
- . Aplicaciones a la intemperie.
- . Sector alimentario.

Pack de 25-50 m.

Rollo de 100 m.



Dimensiones	Presión de trabajo		Código		
	23°C (bar)	23°C (bar)	pack 25 m	pack 50 m	pack 100 m
Tubo					
2x4	30	120	0606806820071	-	0606806820070
4x6	15	60	0606806820073	0606806820074	0606806820072
6x8	10	40	0606806820076	0606806820077	0606806820075
8x10	7,5	30	0606806820079	0606806820080	0606806820078
10x12	6	24	0606806820069	-	0606806820068

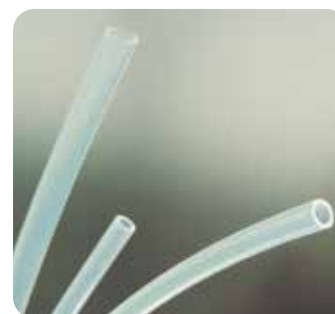

FLUOROPOLÍMERO FEP

TUBO FLUOROPOLÍMERO PFA



CARACTERÍSTICAS:

- . Tubo PFA excelente compatibilidad química.
- . Extremadamente estable a los rayos UV.
- . Excelente superficie lisa.
- . Características antiadherentes.
- . Buenos valores dieléctricos.
- . No inflamable (ignífugo).
- . Es el fluoropolímero con menor permeabilidad.

COLORES:

- . Translúcido.

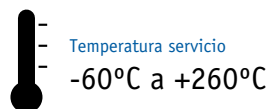

APLICACIONES:

- . Industria química.
- . Industria médica y farmacéutica.
- . Salas blancas.
- . Sector agroalimentario.
- . Electrónica, electricidad y semiconductores.
- . Gases.
- . Aplicaciones con alta exigencia de vida útil.
- . Indicadores de nivel.
- . Aplicaciones a la intemperie.
- . Sector alimentario.

Pack de 25-50 m.

Rollo de 100 m.



CERTIFICACIONES:

- . Aprobación FDA.

Escala corrección de la presión en función del incremento de temperatura

20°C	50°C	100°C	150°C	200°C
100%	90%	75%	60%	40%

Dimensiones	Presión de trabajo		Código		
	23°C (bar)	23°C (bar)	pack 25 m	pack 50 m	pack 100 m
Tubo					
2x4	31	93	0606806820085	-	0606806820084
4x6	20	60	0606806820087	0606806820088	0606806820086
6x8	13	9	0606806820090	0606806820091	0606806820089
8x10	10	30	0606806820093	0606806820094	0606806820092
9x12	13	39	0606806820095	0606806820096	-
10x12	8	24	0606806820082	0606806820083	0606806820081



FLUOROPOLÍMERO PFA



TUBO TEFLÓN CALIBRADO PTFE NATURAL



CARACTERÍSTICAS:

- . Alta resistencia mecánica.
- . Utilización en alimentación.
- . Buena resistencia a la presión.
- . Gran resistencia a los agentes agresivos y corrosivos.
- . Densidad: 2,2 g/cm³.
- . Dureza: 52° Shore D.

CERTIFICACIONES:

- . DIN 53455.
- . Aprobación FDA, uso alimentario.

APLICACIONES:

- . Industria química, alimentación, intercambiadores de calor, equipos médicos, protecciones mecánicas, aislamientos térmicos y eléctricos.

COLOR:

- . Natural.



**OPCIONAL COLORES
NEGRO Y AZUL, BAJO PEDIDO**



TEFLÓN CALIBRADO

MEDIDAS MÉTRICAS

Dimensiones Tubo	Presión de trabajo 23°C (bar)	Tolerancia medidas mm	Código			
			pack 25 m	pack 50 m	pack 100 m	rollo 250 m
1,2x1,8	25	± 0,05	0606806820012	0606806820013	-	0606806820040
2x4	30	± 0,05	0606806820020	0606806820021	0606806820044	-
3x6	30	± 0,08	0606806820022	0606806820023	0606806820045	-
4x6	20	± 0,08	0606806820025	0606806820026	0606806820047	-
5x8	25	± 0,08	0606806820027	0606806820049	-	-
6x8	20	± 0,08	0606806820028	0606806820029	0606806820050	-
6x9	20	± 0,12	0606806820030	0606806820031	0606806820051	-
7x10	18	± 0,12	0606806820032	0606806820033	0606806820053	-
8x10	15	± 0,10	0606806820034	0606806820035	0606806820054	-
9x12	15	± 0,12	0606806820036	0606806820055	0606806820056	-
10x12	10	± 0,12	0606806820009	0606806820010	0606806820037	-
13x16	10	± 0,12	0606806820015	0606806820041	-	-

MEDIDAS PULGADAS

Dimensiones Tubo	Presión de trabajo 23°C (bar)	Tolerancia medidas mm	Código		
			pack 25 m	pack 50 m	pack 100 m
1/16" x 1/8"	30	± 0,05	0606806820018	0606806820019	0606806820043
5/32" x 1/4"	25	± 0,08	0606806820016	0606806820017	0606806820042
1/4" x 3/8"	20	± 0,10	0606806820024	0606806820046	-
3/8" x 1/2"	10	± 0,12	0606806820014	0606806820038	-



Opción de conexión con racores rápidos en PFA diseñados para aplicaciones con líquidos altamente agresivos y con un sistema de montaje extremadamente seguro.



TUBO PVDF

TUBO TERMOPLÁSTICO DE PVDF (POLIFLUORURO DE VINILIDENO)



CARACTERÍSTICAS:

- . Tubo flexible, alta resistencia mecánica y estabilidad dimensional.
- . Buena resistencia a ácidos álcalis, alcoholes y halógenos (para aplicaciones específicas consultar compatibilidad).
- . Alta densidad e impermeabilidad a los gases.
- . Adecuado para instalar con racores instantáneos.

APLICACIONES:

- . Electrónica, fabricación semiconductores, sector médico, químico y nuclear.

COLOR:

- . Natural.

CERTIFICACIONES:

- . Aprobación FDA, uso alimentario.



Temperatura servicio

-50°C a +140°C

Dimensiones	Presión de trabajo	Código		
		pack 25 m	pack 50 m	pack 100 m
Tubo	23°C (bar)			
2x4	72	0606806820103	-	0606806820113
4x6	43	0606806820104	0606806820105	0606806820114
6x8	31	0606806820106	0606806820107	0606806820115
8x10	24	0606806820108	0606806820109	0606806820116
9x12	22	0606806820110	0606806820117	0606806820200
10x12	20	0606806820100	0606806820101	0606806820111
13x16	15	0606806820102	0606806820112	-



PVDF



IMAWELD®

TUBO TERMOPLÁSTICO ELASTÓMERO CON SELLADO POR CALOR Y PROPIEDADES DE SOLDADURA

CARACTERÍSTICAS:

- . Sin ningún ingrediente tóxico, cumple con éxito los requisitos de ausencia de toxicidad.
- . Fabricado y envasado en una sala limpia de clase 10000 auditada por TUV Nord.
- . El sellado térmico y la soldadura facilitan la conexión estéril.
- . Dispone de una buena flexibilidad y acabado superficial con dimensiones y longitudes personalizadas.
- . Superficie de perforación lisa para eliminar el atrapamiento de partículas.
- . Excelente resistencia a ácidos y álcalis.
- . Disponible en blanco opaco (Imaweld®-W) y en color transparente (Imaweld®-T).
- . Método de esterilización: STEAM GAMMA ETO.

CERTIFICACIONES:

- . USP Class VI.
- . FDA 21 CFR 177.2600.
- . NSF - 51.
- . ISO 10933.
- . Libre BPA.
- . DMF #32560 acreditado por la USFDA.
- . ROHS.
- . USP Class 87.
- . TSE/BSE.
- . Phthalate free.
- . Particle free.

* Datos extraíbles bajo petición.



Rollo de 10 m.



USP Class VI



IMAWELD®

www.accesfluid.com



Rollo de 5 m.



USP Class VI



IMALINK®

CONDUCCIÓN TÉCNICA PERSONALIZADA PARA PHARMA

"SINGLE USE"



CARACTERÍSTICAS:

- . Industria farmacéutica.
- . Se fabrican moldeando secciones rectas de tubo o con conectores como T, Y, X y Tri-Clamps.
- . Flujo continuo sin fugas ni restricciones.
- . Personalización, múltiples opciones de distribución.
- . Proceso de fabricación en sala blanca (ISO 7).
- . Sistema listo para instalar en tamaños de 1/16" a 1" en longitudes personalizadas.
- . Conexiones de fácil montaje.
- . Gama esterilizada en autoclave.

CERTIFICACIONES:

- . US-FDA 21 CFR 117.2600.
- . USP Class 87.
- . USP Class VI.
- . ISO 10933.
- . USP 381 Cierre elastomérico para inyección.
- . EP 3.1.9.
- . Prueba extraíble estandarizada BPOG.
- . Fabricados sala esterilizada Clase 1000.

APLICACIONES:

- . Los conjuntos de llenado de un solo uso minimizan el tiempo de preparación, instalación y limpieza.
- . Bombas peristálticas.
- . Filtración y fermentación.
- . Producción de vacunas y bioterapias.



IMALINK®



MEDIDAS DISPONIBLES:

Tubo	
pulgadas	mm
1/16" x 3/16"	1,4 x 4,7
1/16" x 1/4"	1,6 x 6,4
1/16" x 7/16"	1,6 x 11
1/8" x 3/16"	3,2x4,7
1/8" x 1/4"	3,2 x 6,4
1/8" x 5/8"	3,2 x 15,8
3/16" x 1/4"	4,7 x 6,4
3/16" x 7/16"	4,7 x11
1/4" x 7/16"	6,4 x 11
1/4" x 5/8"	6,4 x 15,8
1/4" x 3/4"	6,4 x 19
3/8" x 7/16"	9,52 x 11
3/8" x 5/8"	9,52 x15,8
3/8" x 3/4"	9,52 x 19
1/2" x 5/8"	12,7 x 15,8
1/2" x 3/4"	12,7 x 19
3/4" x 1-1/4"	19 x 31,75

MONTAJES SINGLE USE:

- . Distribuidores.
- . Conexiones asépticas.
- . Refuerzo para tubo (silicona/TPE).
- . Bioproceso conexiones y adaptadores (polipropileno/ PVDF).
- . Tubo (silicona/TPE).
- . Filtros.
- . Bolsas 2D.

APLICACIONES:

- . Producción de vacunas y bioterapias.
- . Cultivo celular y toma de muestras.
- . Llenado aséptico y filtración.
- . Gestión de fluidos estériles.
- . Fermentación y biorreactores.
- . Cromatografía de un solo uso.
- . Bioprocesos.



IMALINK®

CONDUCCIÓN TÉCNICA PERSONALIZADA PARA PHARMA

"SINGLE USE"



CARACTERÍSTICAS:

- . Material: polipropileno.
- . Modo de esterilización: por Autoclave hasta 135°C con un máximo de 30 minutos, irradiado gamma hasta 50 kGy.
- . Condiciones de almacenamiento con el envoltorio original, a poder ser en un lugar seco y frío, fuera del alcance de la luz solar y de productos químicos.
- . Temperatura de almacenamiento de 5 a 40°C son aceptables.

APLICACIONES:

- . Montajes single use.
- . Industrias farmacéuticas.
- . Conexiones para tubo.
- . Salas blancas.

CERTIFICACIONES:

- . FDA 21 CFR 177.1520.
- . USP <88> Prueba de reactividad biológica
- . USP <87> Prueba de reactividad biológica
- . De conformidad.
- . REACH.
- . ROHS.
- . TSE/BSE.
- . Phthalates.
- . Melamina.
- . Bhispenol A.

Rollo de 5 m.



CONECTOR "Y"

Ref.	Tubo Ø ID	
	Pulgadas	mm
PP-YC-0250	1/4"	6.4
PP-YC-0375	3/8"	9.5
PP-YC-0500	1/2"	12,7
PP-YC-0750	3/4"	19,1



CONECTOR "T"

Ref.	Tubo Ø ID	
	Pulgadas	mm
PP-TC-0250	1/4"	6.4
PP-TC-0375	3/8"	9.5
PP-TC-0500	1/2"	12,7
PP-TC-0750	3/4"	19,1
PP-TC-1000	1"	25,4



CONECTOR "CRUZ"

Ref.	Tubo Ø ID	
	Pulgadas	mm
PP-XC-0250	1/4"	6.4
PP-XC-0375	3/8"	9.5
PP-XC-0500	1/2"	12,7
PP-XC-0750	3/4"	19,1



UNIÓN RECTA

Ref.	Tubo Ø ID	
	Pulgadas	mm
PP-STCN-0250	1/4"	6.4
PP-STCN-0375	3/8"	9.5
PP-STCN-0500	1/2"	12,7
PP-STCN-0750	3/4"	19,1



TAPÓN

Ref.	Tubo Ø ID	
	Pulgadas	mm
PP-EC-0750	3/4"	19,1
PP-EC-1500	1.5"	50,5



TAPÓN PARA TUBO

Ref.	Tubo Ø ID	
	Pulgadas	mm
PP-EP-0125	1/8"	3,2
PP-EP-0250	1/4"	6.4
PP-EP-0375	3/8"	9.5
PP-EP-0500	1/2"	12,7
PP-EP-0625	5/8"	15,9
PP-EP-0750	3/4"	19,1



TRICLOVER

Ref.	TRICLOVER	Tubo Ø ID	
		Pulgadas	mm
PP-TC-0.50-0.50HB	1/2" TC	1/2"	12,7
PP-TC-0.75-0.25HB	3/4" TC	1/4"	6.4
PP-TC-0.75-0.37HB	3/4" TC	3/8"	9.5
PP-TC-0.75-0.75HB	3/4" TC	3/4"	19,1
PP-TC-0.75-0.50HB	3/4" TC	1/2"	12,7
PP-TC-1.50-0.50HB	1,5" TC	1/2"	12,7
PP-TC-1.50-0.75HB	1,5" TC	3/4"	19,1
PP-TC-1.50-0.25HB	1,5" TC	1/4"	6.4
PP-TC-1.50-0.37HB	1,5" TC	3/8"	9.5
PP-TC-1.50-1.00HB	1,5" TC	1"	25,4
PP-TC-1.00-0.50HB	1" TC	1/2"	12,7
PP-TC-2.50-0.50HB	2,5" TC	1/2"	12,7
PP-TC-2.50-0.75HB	2,5" TC	3/4"	19,1





Rollo de 5 m.



IMALOK® ACCESORIOS



NEW!

ABRAZADERA SANITARIA

CARACTERÍSTICAS:

- . Industria farmacéutica.
- . Compatible con las normas ASME-BPE y BPSA, no metálicas y de acero inoxidable.
- . Excelente resistencia a ácidos y álcalis.
- . Eficiente sistema de cierre.
- . Ligero.
- . Gama esterilizada en autoclave.
- . Amplio rango de medidas.

APLICACIONES:

- . Sistemas de un solo uso (SUS).
- . Fabricación de productos farmacéuticos.
- . Producción de vacunas y bioterapias.
- . Aplicaciones en las que el metal es incompatible.

NORMAS Y CERTIFICACIONES:

- . FDA 21CFR 177.2600.
- . USP Class 87.
- . USP CLASS VI.



Ref.	Código	Tubo Ø ID	
		Pulgadas	mm
GNRC-NC-0750		1/2" - 3/4"	Nylon reforzado con fibra de vidrio
GNRC-NC-1500		1" - 1 1/2"	

KITS PARA TRANSFERENCIA DE BOTELLA

CARACTERÍSTICAS:

- . Tapón con múltiples puertos que permiten el fácil acceso para los tubos.
- . Diseño para aliviar la tensión de los tubos y prevenir su torsión.
- . Ensamblado y empaquetado en Sala blanca Clase 7.
- . Diferentes configuraciones y orificios personalizados.

NORMAS Y CERTIFICACIONES:

- . FDA 21 CFR 177 Standard.
- . USP Class VI.
- . Animal Derived Component Free (ADCF).
- . Phthalate-free.
- . BPA-free.
- . RoHS.
- . REACH

APLICACIONES:

- . Muestreo.
- . Cultivo de semillas.
- . Preparación de medios, almacenamiento y transferencia.
- . Investigación general de laboratorio.



SONDA DE FUELLE

CARACTERÍSTICAS:

- . Diseñado para solventar las necesidades del single use e industria farmacéutica general.
- . Inserción de pH y oxígeno disuelto conectados de forma aséptica al single use bio reactor.
- . Sala blanca ISO Class 7.
- . Cuerpo flexible.
- . Fácil montaje.
- . Gama estéril y por Autoclave.
- . Soporte entrega rápida.

CERTIFICACIONES:

- . FDA 21 CFR 177 Standard.
- . USP Class VI.



RACORES INSTANTÁNEOS EN ACERO INOX 316L



Versión acero Inox. **INOX**



CARACTERÍSTICAS:

- Cuerpo íntegro en acero Inox AISI 316L.
- Junta en VITÓN (FKM).
- Presión Trabajo: 20bar (regulador 10bar).
- Temperatura: -20°C a +150°C.
- Roscas: BSPT cónica / BSPP cilíndricas.
- Apto para tubos: PA / PU / LDPE / PTFE PVDF / FEP / PFA.
- Certificación alimentaria FDA.
- Alto grado de resistencia química a productos agresivos.
- Gran caudal sin pérdidas de presión.
- Disponibles bajo pedido para tubos en pulgadas y roscas NPT o Métricas.
- Otras figuras disponibles bajo pedido.

APLICACIONES:

- Sector alimentario.
- Industria Química.
- Industria Médica y Farmacéutica.
- Laboratorios.
- Sector Agroalimentario.
- Instrumentación.
- Aplicaciones a la intemperie.

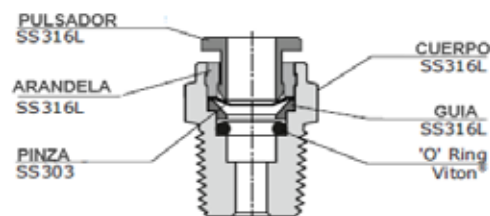

Ref.	Código	Ø Ext. "T"	D	L
GXUC 04-00	0606206220200	4 mm	10.0	34.6
GXUC 06-00	0606206220202	6 mm	12.4	35.6
GXUC 08-00	0606206220205	8 mm	14.0	35.6
GXUC 10-00	0606206220207	10 mm	16.5	35.6
GXUC 12-00	0606206220209	12 mm	19.0	38.8
GXUC 14-00	0606206220212	14 mm	21.8	40.8
GXUC 16-00	0606206220213	16 mm	23.3	40.8

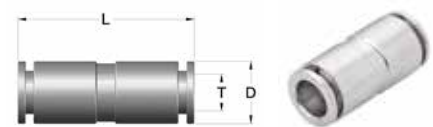

GXUC
Unión Tubo-Tubo.

Ref.	Código	Ø Ext. "T"	D1	D2	L
GXUC 04-06	0606206220201	4mm/6mm	10.0	12.4	35.5
GXUC 06-08	0606206220203	6mm/8mm	12.4	14.0	36.0
GXUC 06-10	0606206220204	6mm/10mm	12.4	16.5	36.0
GXUC 08-10	0606206220206	8mm/10mm	14.0	16.5	36.0
GXUC 10-12	0606206220208	10mm/12mm	16.5	19.0	37.4
GXUC 12-14	0606206220210	12mm/14mm	19.0	21.8	39.8
GXUC 12-16	0606206220211	12mm/16mm	19.0	23.3	39.4

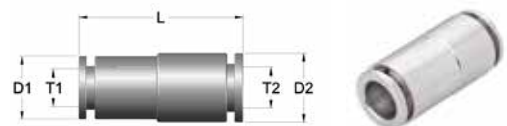

GXUC
Reducción Tubo-Tubo.

Ref.	Código	T2/T1	D	L
GXGJ 06-04	0606206220079	6mm/4mm	10.0	41.8
GXGJ 08-04	0606206220080	8mm/4mm	10.0	41.8
GXGJ 08-06	0606206220081	8mm/6mm	12.4	41.8
GXGJ 10-06	0606206220082	10mm/6mm	12.4	42.8
GXGJ 10-08	0606206220083	10mm/8mm	14.0	42.8
GXGJ 12-08	0606206220085	12mm/8mm	14.0	45.8
GXGJ 12-10	0606206220086	12mm/10mm	16.5	46.3
GXGJ 14-12	0606206220087	14mm/12mm	19.0	47.8
GXGJ 16-14	0606206220088	16mm/14mm	19.0	47.8

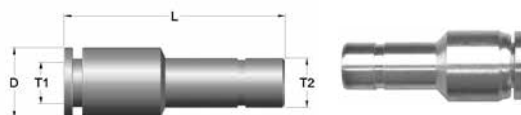

GXGJ
Reductor Tubo.

Ref.	Código	Ø Ext. "T"	D	L1	L2	G	H	A/F
GXMM 04-00	0606206220142	4 mm	10.0	33.0	18.8	6.0	M11x0.75	14.0
GXMM 06-00	0606206220143	6 mm	12.4	35.0	19.3	6.0	M14x1	19.0
GXMM 08-00	0606206220144	8 mm	14.0	36.0	20.3	6.0	M16x1	20.6
GXMM 10-00	0606206220145	10 mm	16.5	42.0	24.8	8.0	M18x1	22.0
GXMM 12-00	0606206220146	12 mm	19.0	46.4	25.2	10.0	M22x1.5	27.0
GXMM 14-00	0606206220147	14 mm	21.8	48.4	27.2	10.0	M24x1.5	28.6
GXMM 16-00	0606206220148	16 mm	23.3	48.4	27.2	10.0	M26x1.5	30.0

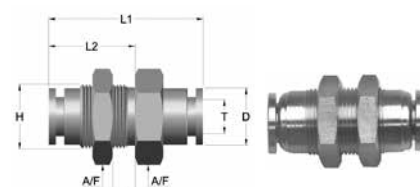

GXMM
Unión Tubo-Tubo pasamuros.

RACORES INSTANTÁNEOS EN ACERO INOX 316L



Versión acero Inox.

INOX



Ref.	Código	Ø Ext. "T"	P	B	D	L	A/F
GXC 04-01	0606206220001	4 mm	R1/8"	7.5	10.0	22.6	11.0
GXC 04-02	0606206220002	4 mm	R1/4"	11.0	10.0	23.3	14.0
GXC 06-01	0606206220005	6 mm	R1/8"	7.5	12.4	23.3	13.0
GXC 06-02	0606206220006	6 mm	R1/4"	11.0	12.4	22.8	14.0
GXC 08-01	0606206220010	8 mm	R1/8"	7.5	14.0	26.3	14.0
GXC 08-02	0606206220012	8 mm	R1/4"	11.0	14.0	26.3	14.0
GXC 08-03	0606206220013	8 mm	R3/8"	11.5	14.0	24.3	17.0
GXC 10-02	0606206220017	10 mm	R1/4"	11.0	16.5	29.3	17.0
GXC 10-03	0606206220018	10 mm	R3/8"	11.5	16.5	26.8	17.0
GXC 10-04	0606206220019	10 mm	R1/2"	15.0	16.5	27.8	22.0
GXC 12-02	0606206220023	12 mm	R1/4"	11.0	19.0	31.0	20.6
GXC 12-03	0606206220024	12 mm	R3/8"	11.5	19.0	28.2	20.6
GXC 12-04	0606206220025	12 mm	R1/2"	15.0	19.0	28.2	22.0
GXC 14-04	0606206220029	14 mm	R1/2"	15.0	21.8	32.2	22.0
GXC 16-04	0606206220032	16 mm	R1/2"	15.0	23.3	33.2	24.0

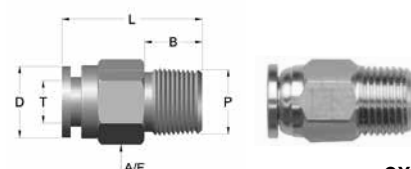

GXC
Recto Tubo-Rosca macho BSPT (cónica)

Ref.	Código	Ø Ext. "T"	P	B	D	L	A/F
GXC 04-M5	0606206220004	4 mm	M5	5.0	10.0	23.8	11.0
GXC 04-G01	0606206220003	4 mm	G1/8"	5.8	10.0	22.8	14.0
GXC 04-G02	A CONSULTAR	4 mm	G1/4"	7.5	10.0	23.8	17.0
GXC 06-G01	0606206220007	6 mm	G1/8"	5.8	12.4	24.3	14.0
GXC 06-G02	0606206220008	6 mm	G1/4"	7.5	12.4	23.3	17.0
GXC 08-G01	0606206220014	8 mm	G1/8"	5.8	14.0	25.3	14.0
GXC 08-G02	0606206220015	8 mm	G1/4"	7.5	14.0	24.0	17.0
GXC 08-G03	0606206220016	8 mm	G3/8"	7.5	14.0	23.8	20.6
GXC 10-G02	0606206220020	10 mm	G1/4"	7.5	16.5	27.4	17.0
GXC 10-G03	0606206220021	10 mm	G3/8"	7.5	16.5	24.3	20.6
GXC 10-G04	0606206220022	10 mm	G1/2"	10.0	16.5	26.0	27.0
GXC 12-G02	0606206220026	12 mm	G1/4"	7.5	19.0	28.4	17.0
GXC 12-G03	0606206220027	12 mm	G3/8"	7.5	19.0	28.8	20.6
GXC 12-G04	0606206220028	12 mm	G1/2"	10.0	19.0	28.4	27.0
GXC 14-G04	0606206220030	14 mm	G1/2"	10.0	21.8	29.2	27.0
GXC 16-G04	0606206220033	16 mm	G1/2"	10.0	23.3	32.2	27.0

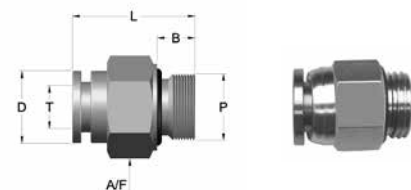

GXC-G
Recto Tubo-Rosca macho BSPP (cilíndrica)

Ref.	Código	Ø Ext. "T"	P	D	L	A/F
GXF 04-G01	0606206220065	4 mm	G1/8"	10.0	28.8	13.0
GXF 06-G01	0606206220066	6 mm	G1/8"	12.4	29.3	13.0
GXF 06-G02	0606206220067	6 mm	G1/4"	12.4	30.8	17.0
GXF 08-G01	0606206220068	8 mm	G1/8"	14.0	29.8	14.0
GXF 08-G02	0606206220069	8 mm	G1/4"	14.0	30.3	17.0
GXF 08-G03	0606206220070	8 mm	G3/8"	14.0	30.8	20.6
GXF 10-G02	0606206220071	10 mm	G1/4"	16.5	31.3	17.0
GXF 10-G03	0606206220072	10 mm	G3/8"	16.5	30.8	20.6
GXF 10-G04	0606206220073	10 mm	G1/2"	16.5	33.6	27.0
GXF 12-G02	0606206220074	12 mm	G1/4"	19.0	31.8	20.6
GXF 12-G03	0606206220075	12 mm	G3/8"	19.0	32.2	20.6
GXF 12-G04	0606206220076	12 mm	G1/2"	19.0	35.0	27.0
GXF 14-G04	0606206220077	14 mm	G1/2"	21.8	36.0	27.0
GXF 16-G04	0606206220078	16 mm	G1/2"	23.3	35.4	27.0

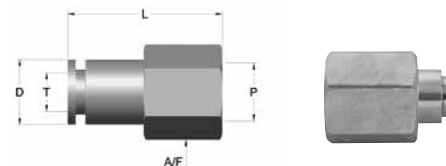

GXF-G
Recto Tubo-Rosca hembra BSPP (cilíndrica)

Ref.	Código	Ø Ext. "T"	D	L	A/F
GXUL 04-00	0606206220214	4 mm	10.0	20.3	10.0
GXUL 06-00	0606206220215	6 mm	12.4	22.0	12.0
GXUL 08-00	0606206220216	8 mm	14.0	23.2	14.0
GXUL 10-00	0606206220217	10 mm	16.5	24.3	16.0
GXUL 12-00	0606206220218	12 mm	19.5	26.7	19.0
GXUL 14-00	0606206220219	14 mm	21.8	28.7	22.0
GXUL 16-00	0606206220220	16 mm	23.3	30.0	24.0

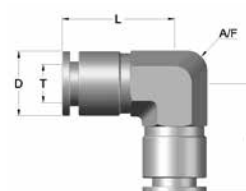

GXUL
Codo 90° Tubo-Tubo

RACORES INSTANTÁNEOS EN ACERO INOX 316L



Versión acero Inox.

INOX

CERTIFICACIÓN
FDA

Ref.	Código	Ø Ext. "T"	P	D	L1	L2	G	H	A/F
GXMF 04-G01	0606206220128	4 mm	G1/8"	10.0	31.3	18.8	6.0	M12X1	16.0
GXMF 06-G01	0606206220129	6 mm	G1/8"	12.4	31.3	19.3	6.0	M14X1	19.0
GXMF 06-G02	0606206220130	6 mm	G1/4"	12.4	33.3	19.3	6.0	M14X1	19.0
GXMF 08-G01	0606206220131	8 mm	G1/8"	14.0	31.8	20.3	6.0	M16X1	20.6
GXMF 08-G02	0606206220132	8 mm	G1/4"	14.0	34.8	20.3	6.0	M16X1	20.6
GXMF 08-G03	0606206220133	8 mm	G3/8"	14.0	34.8	20.3	6.0	M16X1	20.6
GXMF 10-G02	0606206220134	10 mm	G1/4"	16.5	35.8	24.8	8.0	M18X1	22.0
GXMF 10-G03	0606206220135	10 mm	G3/8"	16.5	37.8	24.8	8.0	M18X1	22.0
GXMF 10-G04	0606206220136	10 mm	G1/2"	16.5	41.3	24.8	8.0	M18X1	27.0
GXMF 12-G02	0606206220137	12 mm	G1/4"	19.0	37.2	25.2	10.0	M22X1.5	27.0
GXMF 12-G03	0606206220138	12 mm	G3/8"	19.0	37.2	25.2	10.0	M22X1.5	27.0
GXMF 12-G04	0606206220139	12 mm	G1/2"	19.0	41.7	25.2	10.0	M22X1.5	27.0
GXMF 14-G04	0606206220140	14 mm	G1/2"	21.8	41.7	27.2	10.0	M24X1.5	28.6
GXMF 16-G04	0606206220141	16 mm	G1/2"	23.3	39.2	27.2	10.0	M26X1.5	30.0

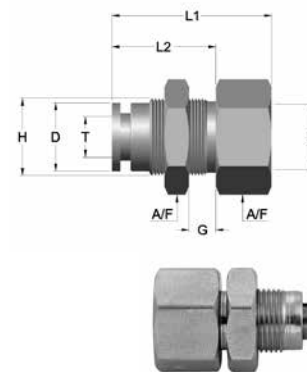

GXMF-G
Recto Tubo-Rosca hembra pasamuros
BSPP (cilíndrica)

Ref.	Código	Ø Ext. "T"	P	B	D	L1	L2	A/F1	A/F2
GXL 04-01	0606206220089	4 mm	R1/8"	7.5	10.0	20.3	25.6	10.0	11.0
GXL 06-01	0606206220092	6 mm	R1/8"	7.5	12.4	22.0	26.8	12.0	13.0
GXL 06-02	0606206220093	6 mm	R1/4"	11.0	12.4	22.0	30.5	12.0	14.0
GXL 08-01	0606206220097	8 mm	R1/8"	7.5	14.0	23.2	27.8	14.0	14.0
GXL 08-02	0606206220098	8 mm	R1/4"	11.0	14.0	23.2	31.5	14.0	14.0
GXL 08-03	0606206220099	8 mm	R3/8"	11.5	14.0	23.2	32.3	14.0	17.0
GXL 10-02	0606206220103	10 mm	R1/4"	11.0	16.5	24.3	33.0	16.0	16.0
GXL 10-03	0606206220104	10 mm	R3/8"	11.5	16.5	24.3	33.7	16.0	17.0
GXL 10-04	0606206220105	10 mm	R1/2"	15.0	16.5	24.3	37.5	16.0	22.0
GXL 12-02	0606206220109	12 mm	R1/4"	11.0	19.0	26.7	35.0	19.0	19.0
GXL 12-03	0606206220110	12 mm	R3/8"	11.5	19.0	26.7	35.6	19.0	19.0
GXL 12-04	0606206220111	12 mm	R1/2"	15.0	19.0	26.7	39.4	19.0	22.0
GXL 14-04	0606206220115	14 mm	R1/2"	15.0	21.8	28.7	42.2	22.0	22.0
GXL 16-04	0606206220117	16 mm	R1/2"	15.0	23.3	30.0	43.5	24.0	24.0

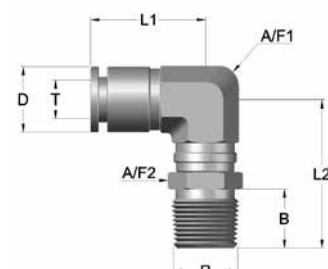

GXL
Codo 90° Tubo-rosca macho
BSPT (cónica orientable)

Ref.	Código	Ø Ext. "T"	R	P	D	L1	L2	A/F1	A/F2
GXL 04-M5	0606206220091	4 mm	M5	5.0	10.0	20.3	24.0	10.0	11.0
GXL 04-G01	0606206220090	4 mm	G1/8"	5.8	10.0	20.3	24.9	10.0	14.0
GXL 06-M6	0606206220096	6 mm	M6	5.3	12.4	22.0	25.7	12.0	13.0
GXL 06-G01	0606206220094	6 mm	G1/8"	5.8	12.4	22.0	26.0	12.0	14.0
GXL 06-G02	0606206220095	6 mm	G1/4"	7.5	12.4	22.0	28.0	12.0	17.0
GXL 08-G01	0606206220100	8 mm	G1/8"	5.8	14.0	23.2	27.0	14.0	14.0
GXL 08-G02	0606206220101	8 mm	G1/4"	7.5	14.0	23.2	29.0	14.0	17.0
GXL 08-G03	0606206220102	8 mm	G3/8"	7.5	14.0	23.2	29.5	14.0	20.6
GXL 10-G02	0606206220106	10 mm	G1/4"	7.5	16.5	24.3	30.3	16.0	17.0
GXL 10-G03	0606206220107	10 mm	G3/8"	7.5	16.5	24.3	30.7	16.0	20.6
GXL 10-G04	0606206220108	10 mm	G1/2"	10.0	16.5	24.3	33.8	16.0	27.0
GXL 12-G02	0606206220112	12 mm	G1/4"	7.5	19.0	26.7	32.8	19.0	19.0
GXL 12-G03	0606206220113	12 mm	G3/8"	7.5	19.0	26.7	32.6	19.0	20.6
GXL 12-G04	0606206220114	12 mm	G1/2"	10.0	19.0	26.7	35.8	19.0	27.0
GXL 14-G04	0606206220116	14 mm	G1/2"	10.0	21.8	28.7	38.4	22.0	27.0
GXL 16-G04	0606206220118	16 mm	G1/2"	10.0	23.3	30.0	39.6	24.0	27.0

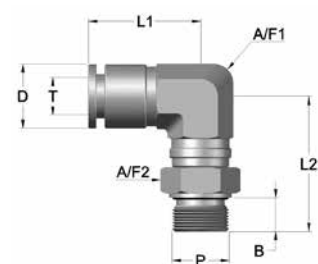

GXL-G
Codo 90° Tubo-rosca macho
BSPP (cilíndrica orientable)



RACORES INSTANTÁNEOS EN ACERO INOX 316L



Versión acero Inox.



Ref.	Código	Ø Ext. "T"	P	B	D	L1	L2	A/F
GXLI 04-01	0606206220119	4 mm	R1/8"	7.5	10.0	20.3	16.0	10.0
GXLI 06-01	0606206220120	6 mm	R1/8"	7.5	12.4	22.0	17.2	12.0
GXLI 06-02	0606206220121	6 mm	R1/4"	11.0	12.4	23.2	22.0	14.0
GXLI 08-01	0606206220122	8 mm	R1/8"	7.5	14.0	23.2	18.2	14.0
GXLI 08-02	0606206220123	8 mm	R1/4"	11.0	14.0	23.2	21.7	14.0
GXLI 10-02	0606206220124	10 mm	R1/4"	11.0	16.5	24.3	23.0	16.0
GXLI 10-03	0606206220125	10 mm	R3/8"	11.5	16.5	24.3	23.5	16.0
GXLI 12-02	0606206220126	12 mm	R1/4"	11.0	19.0	26.7	24.5	19.0
GXLI 12-03	0606206220127	12 mm	R3/8"	11.5	19.0	26.7	25.0	19.0

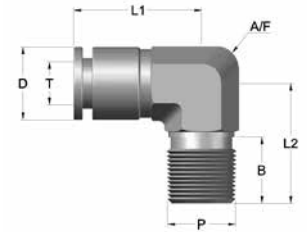

GXLI
Codo 90° Tubo-rosca macho BSPT (cónica FIJA)

Ref.	Código	Ø Ext. "T"	D	L	A/F
GXUT 04-00	0606206220221	4 mm	10.0	20.3	10.0
GXUT 06-00	0606206220222	6 mm	12.4	22.0	12.0
GXUT 08-00	0606206220223	8 mm	14.0	23.2	14.0
GXUT 10-00	0606206220224	10 mm	16.5	24.3	16.0
GXUT 12-00	0606206220225	12 mm	19.0	26.7	19.0
GXUT 14-00	0606206220226	14 mm	21.8	28.7	22.0
GXUT 16-00	0606206220227	16 mm	23.3	30.0	24.0

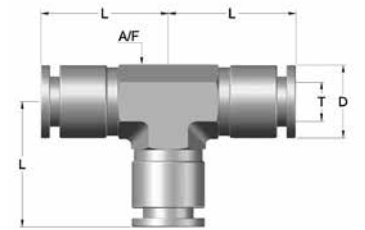

GXUT
"T" Tubo-Tubo-Tubo

Ref.	Código	Ø Ext. "T"	P	B	D	L1	L2	A/F1	A/F2
GXT 04-M5	0606206220151	4 mm	M5	5.0	10.0	20.3	24.0	10.0	11.0
GXT 04-G01	0606206220150	4 mm	G1/8"	5.8	10.0	20.3	24.9	10.0	14.0
GXT 06-M6	0606206220156	6 mm	M6	5.3	12.4	22.0	25.7	12.0	13.0
GXT 06-G01	0606206220154	6 mm	G1/8"	5.8	12.4	22.0	26.0	12.0	14.0
GXT 06-G02	0606206220155	6 mm	G1/4"	7.5	12.4	22.0	28.0	12.0	17.0
GXT 08-G01	0606206220160	8 mm	G1/8"	5.8	14.0	23.2	27.0	14.0	14.0
GXT 08-G02	0606206220161	8 mm	G1/4"	7.5	14.0	23.2	29.0	14.0	17.0
GXT 08-G03	0606206220162	8 mm	G3/8"	7.5	14.0	23.2	29.5	14.0	20.6
GXT 10-G02	0606206220166	10 mm	G1/4"	7.5	16.5	24.3	30.3	16.0	17.0
GXT 10-G03	0606206220167	10 mm	G3/8"	7.5	16.5	24.3	30.7	16.0	20.6
GXT 10-G04	0606206220168	10 mm	G1/2"	10.0	16.5	24.3	33.8	16.0	27.0
GXT 12-G02	0606206220172	12 mm	G1/4"	7.5	19.0	26.7	32.8	19.0	19.0
GXT 12-G03	0606206220173	12 mm	G3/8"	7.5	19.0	26.7	32.6	19.0	20.6
GXT 12-G04	0606206220174	12 mm	G1/2"	10.0	19.0	26.7	35.8	19.0	27.0
GXT 14-G04	0606206220176	14 mm	G1/2"	10.0	21.8	28.7	38.4	22.0	27.0
GXT 16-G04	0606206220178	16 mm	G1/2"	10.0	23.3	30.0	39.6	24.0	27.0

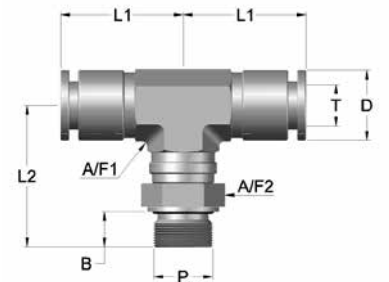

GXT-G
"T" Tubo - Rosca macho
BSPP (cilíndrica orientable) - Tubo

Ref.	Código	Ø Ext. "T"	P	B	D	L1	L2	A/F1	A/F2
GXT 04-01	0606206220149	4 mm	R1/8"	7.5	10.0	20.3	25.6	10.0	11.0
GXT 06-01	0606206220152	6 mm	R1/8"	7.5	12.4	22.0	26.8	12.0	13.0
GXT 06-02	0606206220153	6 mm	R1/4"	11.0	12.4	22.0	30.5	12.0	14.0
GXT 08-01	0606206220157	8 mm	R1/8"	7.5	14.0	23.2	27.8	14.0	14.0
GXT 08-02	0606206220158	8 mm	R1/4"	11.0	14.0	23.2	31.5	14.0	14.0
GXT 08-03	0606206220159	8 mm	R3/8"	11.5	14.0	23.2	32.3	14.0	17.0
GXT 10-02	0606206220163	10 mm	R1/4"	11.0	16.5	24.3	33.0	16.0	16.0
GXT 10-03	0606206220164	10 mm	R3/8"	11.5	16.5	24.3	33.7	16.0	17.0
GXT 10-04	0606206220165	10 mm	R1/2"	15.0	16.5	24.3	37.5	16.0	22.0
GXT 12-02	0606206220169	12 mm	R1/4"	11.0	19.0	26.7	35.0	19.0	19.0
GXT 12-03	0606206220170	12 mm	R3/8"	11.5	19.0	26.7	35.6	19.0	19.0
GXT 12-04	0606206220171	12 mm	R1/2"	15.0	19.0	26.7	39.4	19.0	22.0
GXT 14-04	0606206220175	14 mm	R1/2"	15.0	21.8	28.7	42.2	22.0	22.0
GXT 16-04	0606206220177	16 mm	R1/2"	15.0	23.3	30.0	43.5	24.0	24.0

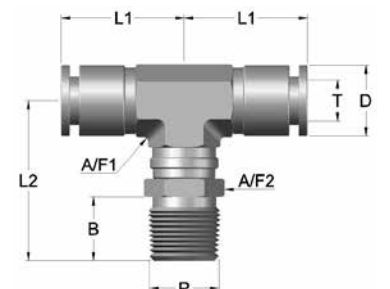

GXT
"T" Tubo - Rosca macho
BSPT (cónica orientable) - Tubo

RACORES INSTANTÁNEOS EN ACERO INOX 316L



Versión acero Inox.

INOX

CERTIFICACIÓN
FDA

Ref.	Código	Ø Ext."T"	P	B	D	L1	L2	A/F
GXTI 04-01	0606206220193	4 mm	R1/8"	7.5	10.0	20.3	16.0	10.0
GXTI 06-01	0606206220194	6 mm	R1/8"	7.5	12.4	22.0	17.2	12.0
GXTI 06-02	0606206220195	6 mm	R1/4"	11.0	12.4	23.2	22.0	14.0
GXTI 08-01	0606206220196	8 mm	R1/8"	7.5	14.0	23.2	18.5	14.0
GXTI 08-02	0606206220197	8 mm	R1/4"	11.0	14.0	23.2	21.7	14.0
GXTI 10-02	0606206220198	10 mm	R1/4"	11.0	16.5	24.3	23.0	16.0
GXTI 12-02	0606206220199	12 mm	R1/4"	11.0	19.0	26.7	24.5	19.0

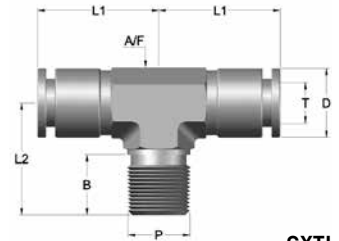

GXTI
"T" Tubo - Rosca macho BSPT (cónica fija) - Tubo

Ref.	Código	Ø Ext."T"	P	D	L1	L2	A/F1	A/F2
GXTF 04-G01	0606206220179	4 mm	G1/8"	10.0	20.3	25.1	10.0	13.0
GXTF 06-G01	0606206220180	6 mm	G1/8"	12.4	22.0	26.5	12.0	13.0
GXTF 06-G02	0606206220181	6 mm	G1/4"	12.4	22.0	28.5	12.0	17.0
GXTF 08-G01	0606206220182	8 mm	G1/8"	14.0	23.2	27.5	14.0	14.0
GXTF 08-G02	0606206220183	8 mm	G1/4"	14.0	23.2	29.5	14.0	17.0
GXTF 08-G03	0606206220184	8 mm	G3/8"	14.0	23.2	30.2	14.0	20.6
GXTF 10-G02	0606206220185	10 mm	G1/4"	16.5	24.3	31.0	16.0	17.0
GXTF 10-G03	0606206220186	10 mm	G3/8"	16.5	24.3	30.8	16.0	20.6
GXTF 10-G04	0606206220187	10 mm	G1/2"	16.5	24.3	32.5	16.0	27.0
GXTF 12-G02	0606206220188	12 mm	G1/4"	19.0	26.7	32.8	19.0	19.0
GXTF 12-G03	0606206220189	12 mm	G3/8"	19.0	26.7	32.8	19.0	20.6
GXTF 12-G04	0606206220190	12 mm	G1/2"	19.0	26.7	34.3	19.0	27.0
GXTF 14-G04	0606206220191	14 mm	G1/2"	21.8	28.7	36.9	22.0	27.0
GXTF 16-G04	0606206220192	16 mm	G1/2"	23.3	30.0	38.3	24.0	27.0

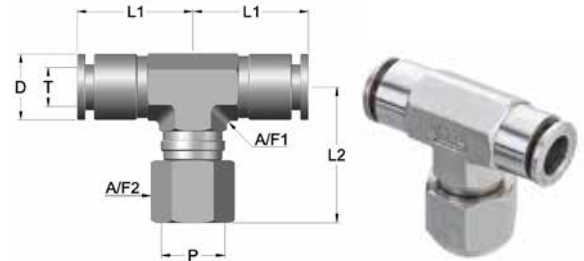

GXTF-G
"T" Tubo - Rosca hembra BSPP (cilíndrica orientable) - Tubo

Ref.	Código	Ø Ext."T"	D	L	A/F
GXZ 04-00	0606206220228	4 mm	10.0	20.3	10.0
GXZ 06-00	0606206220229	6 mm	12.4	22.0	12.0
GXZ 08-00	0606206220230	8 mm	14.0	23.2	14.0
GXZ 10-00	0606206220231	10 mm	16.5	24.3	16.0
GXZ 12-00	0606206220232	12 mm	19.0	26.7	19.0
GXZ 14-00	0606206220233	14 mm	21.8	28.7	22.0
GXZ 16-00	0606206220234	16 mm	23.3	30.0	24.0

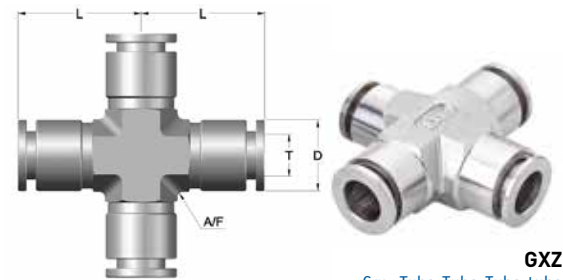

GXZ
Cruz Tubo-Tubo-Tubo-tubo

Ref.	Código	Ø Ext."T"	P	B	L	A/F
GXCJ 04-01	0606206220034	4 mm	R1/8"	7.5	35.3	11.0
GXCJ 04-02	0606206220035	4 mm	R1/4"	11.0	39.0	14.0
GXCJ 06-01	0606206220039	6 mm	R1/8"	7.5	36.3	11.0
GXCJ 06-02	0606206220040	6 mm	R1/4"	11.0	40.0	14.0
GXCJ 08-01	0606206220043	8 mm	R1/8"	7.5	36.3	11.0
GXCJ 08-02	0606206220044	8 mm	R1/4"	11.0	40.0	14.0
GXCJ 08-03	0606206220045	8 mm	R3/8"	11.5	40.8	17.0
GXCJ 10-02	0606206220049	10 mm	R1/4"	11.0	41.0	14.0
GXCJ 10-03	0606206220050	10 mm	R3/8"	11.5	41.8	17.0
GXCJ 10-04	0606206220051	10 mm	R1/2"	15.0	46.0	22.0
GXCJ 12-02	0606206220055	12 mm	R1/4"	11.0	43.0	14.0
GXCJ 12-03	0606206220056	12 mm	R3/8"	11.5	43.8	17.0
GXCJ 12-04	0606206220057	12 mm	R1/2"	15.0	47.8	22.0
GXCJ 14-04	0606206220061	14 mm	R1/2"	15.0	49.0	22.0
GXCJ 16-04	0606206220063	16 mm	R1/2"	15.0	49.0	22.0

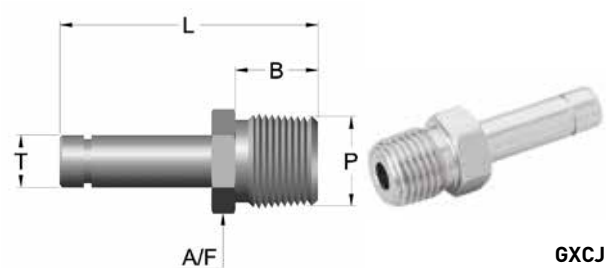

GXCJ
Adaptador Tubo-Rosca macho BSPT (cónica)



RACORES INSTANTÁNEOS EN ACERO INOX 316L



Versión acero Inox.



Ref.	Código	Ø Ext. "T"	P	B	L	A/F
GXCJ 04-M5	0606206220038	4 mm	M5	5.0	34.0	11.0
GXCJ 04-G01	0606206220036	4 mm	G1/8"	5.8	35.3	14.0
GXCJ 04-G02	0606206220037	4 mm	G1/4"	7.5	35.8	17.0
GXCJ 06-G01	0606206220041	6 mm	G1/8"	5.8	35.8	14.0
GXCJ 06-G02	0606206220042	6 mm	G1/4"	7.5	37.8	17.0
GXCJ 08-G01	0606206220046	8 mm	G1/8"	5.8	35.8	14.0
GXCJ 08-G02	0606206220047	8 mm	G1/4"	7.5	37.8	17.0
GXCJ 08-G03	0606206220048	8 mm	G3/8"	7.5	38.3	20.6
GXCJ 10-G02	0606206220052	10 mm	G1/4"	7.5	38.8	17.0
GXCJ 10-G03	0606206220053	10 mm	G3/8"	7.5	39.3	20.6
GXCJ 10-G04	0606206220054	10 mm	G1/2"	10.0	42.6	27.0
GXCJ 12-G02	0606206220058	12 mm	G1/4"	7.5	40.8	17.0
GXCJ 12-G03	0606206220059	12 mm	G3/8"	7.5	40.8	20.6
GXCJ 12-G04	0606206220060	12 mm	G1/2"	10.0	44.6	27.0
GXCJ 14-G04	0606206220062	14 mm	G1/2"	10.0	45.6	27.0
GXCJ 16-G04	0606206220064	16 mm	G1/2"	10.0	45.6	27.0

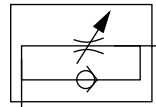
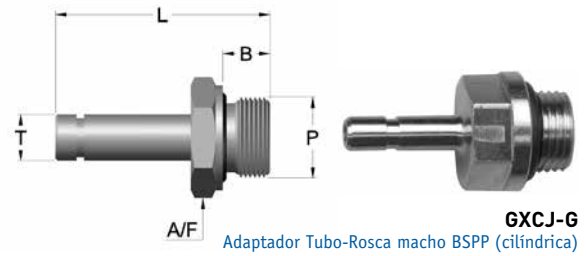

Ref.	Código	Ø Ext. "T"	P	B	C	D	A/F1	A/F2
VXEL 04-M5	A CONSULTAR	4 mm	M5	4.0	24.0	14.0	11.0	9.5
VXEL 06-G01	0707507510097	6 mm	G1/8"	6.0	38.0	24.0	14.3	14.3
VXEL 06-G02	0707507510098	6 mm	G1/4"	8.0	43.0	27.0	19.0	17.4
VXEL 08-G01	0707507510099	8 mm	G1/8"	6.0	38.0	24.0	14.3	14.3
VXEL 08-G02	0707507510100	8 mm	G1/4"	8.0	43.0	27.0	19.0	17.4
VXEL 10-G02	0707507510101	10 mm	G1/4"	8.0	43.0	27.0	19.0	17.4
VXEL 10-G03	0707507510102	10 mm	G3/8"	8.0	51.0	31.0	22.0	20.6
VXEL 12-G03	0707507510103	12 mm	G3/8"	8.0	51.0	31.0	22.0	20.6
VXEL 12-G04	0707507510104	12 mm	G1/2"	10.0	57.0	33.0	27.0	24.0

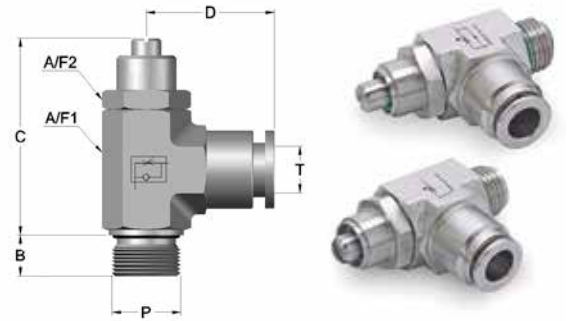

Ref.	Código	Ø Ext. "T"	P	B	D	L	A/F
VXA 06-G02	0606206220357	6 mm	G1/4"	7.5	12.4	29.3	17.0
VXA 08-G02	0606206220358	8 mm	G1/4"	7.5	14.0	30.4	17.0
VXA 10-G03	0606206220359	10 mm	G3/8"	7.5	16.5	31.8	20.6

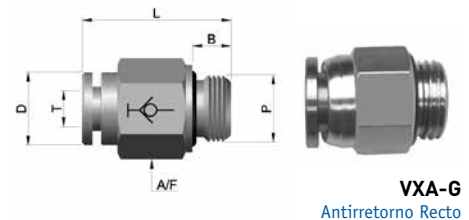

RACORES RÁPIDOS EN ACERO INOX 316L



CERTIFICACIÓN
FDA

CARACTERÍSTICAS:

- . Cuerpo y tuerca: Acero Inox 316L.
- . Juntas rosca: Vitón®
- . Roscas: BSPT cónica / BSPP cilíndricas.
- . Apto para tubo: Poliamida / Poliuretano / Polietileno / PTFE / PVDF / FEP / PFA.
- . Racores contruïdos íntegramente en Inox 316L.
- . Alto grado de resistencia química a productos agresivos.
- . Gran caudal sin pérdidas de presión.
- . Disponibles bajo pedido para tubos en pulgadas y roscas NPT o Métricas.
- . Presión de trabajo: 20 bar.
- . Temperatura máxima: 0°C a +160°C.
(Considerar temperatura máx. tubo utilizado).

APLICACIONES:

- . Industria Química.
- . Sector alimentario.
- . Industria Médica y Farmacéutica.
- . Laboratorios.
- . Sector Agroalimentario.
- . Instrumentación.
- . Aplicaciones a la intemperie.

Ref.	Código	Ø Tubo	Rosca P	B	F-HEX	G-HEX	L
RCX 0601	0606206220271	4x6	1/8"	7.5	11.0	13.0	26.5
RCX 0602	0606206220272	4x6	1/4"	11.0	14.0	13.0	30.2
RCX 0801	0606206220273	6x8	1/8"	7.5	14.0	14.0	28.0
RCX 0802	0606206220274	6x8	1/4"	11.0	14.0	14.0	31.5
RCX 0803	0606206220275	6x8	3/8"	11.5	17.0	14.0	32.4
RCX 1001	0606206220276	8x10	1/8"	7.5	16.0	16.0	28.4
RCX 1002	0606206220277	8x10	1/4"	11.0	16.0	16.0	32.0
RCX 1003	0606206220278	8x10	3/8"	11.5	17.0	16.0	32.5
RCX 12902	0606206220282	9x12	1/4"	11.0	17.0	19.0	33.7
RCX 12903	0606206220283	9x12	3/8"	11.5	17.0	19.0	34.2
RCX 1202	0606206220279	10x12	1/4"	11.0	17.0	19.0	33.7
RCX 1203	0606206220280	10x12	3/8"	11.5	17.0	19.0	34.2
RCX 1204	0606206220281	10x12	1/2"	15.0	22.0	19.0	38.0

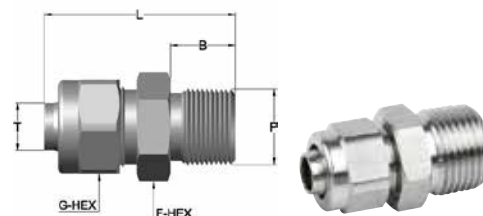

RCX
Recto rosca macho cónica BSPT

Ref.	Código	Ø Tubo	Rosca P	B	D	F-HEX	G-HEX	L
RCIX 06G01	0606206220258	4x6	1/8"	5.8	13.8	14.0	13.0	26.0
RCIX 06G02	0606206220259	4x6	1/4"	7.5	16.8	17.0	13.0	28.0
RCIX 08G01	0606206220260	6x8	1/8"	5.8	13.8	14.0	14.0	27.7
RCIX 08G02	0606206220261	6x8	1/4"	7.5	16.8	17.0	14.0	29.7
RCIX 08G03	0606206220262	6x8	3/8"	7.5	20.3	20.6	14.0	30.0
RCIX 10G01	0606206220263	8x10	1/8"	5.8	13.8	16.0	16.0	27.6
RCIX 10G02	0606206220264	8x10	1/4"	7.5	16.8	17.0	16.0	29.8
RCIX 10G03	0606206220265	8x10	3/8"	7.5	20.3	20.6	16.0	30.0
RCIX 129G02	0606206220266	9x12	1/4"	7.5	16.8	17.0	19.0	31.6
RCIX 129G03	0606206220267	9x12	3/8"	7.5	20.3	20.6	19.0	31.6
RCIX 12G02	0606206220268	10x12	1/4"	7.5	16.8	17.0	19.0	31.6
RCIX 12G03	0606206220269	10x12	3/8"	7.5	20.3	20.6	19.0	31.6
RCIX 12G04	0606206220270	10x12	1/2"	10.0	26.6	27.0	19.0	34.2

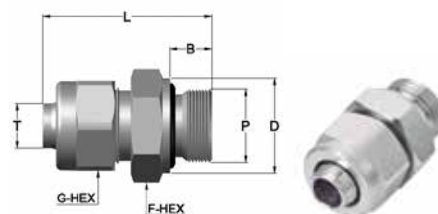

RCIX -G
Recto rosca macho cilíndrica BSPP

Ref.	Código	Ø Tubo	Rosca P	F-HEX	G-HEX	L
RCFX 0601	0606206220246	4x6	1/8"	13.0	13.0	26.0
RCFX 0602	0606206220247	4x6	1/4"	17.0	13.0	28.0
RCFX 0801	0606206220248	6x8	1/8"	13.0	14.0	27.5
RCFX 0802	0606206220249	6x8	1/4"	17.0	14.0	29.5
RCFX 0803	0606206220250	6x8	3/8"	20.6	14.0	29.5
RCFX 1001	0606206220251	8x10	1/8"	16.0	16.0	27.4
RCFX 1002	0606206220252	8x10	1/4"	17.0	16.0	29.5
RCFX 1003	0606206220253	8x10	3/8"	20.6	16.0	29.5
RCFX 12902	0606206220256	9x12	1/4"	17.0	19.0	31.0
RCFX 12903	0606206220257	9x12	3/8"	20.6	19.0	31.0
RCFX 1202	0606206220254	10x12	1/4"	17.0	19.0	31.0
RCFX 1203	0606206220255	10x12	3/8"	20.6	19.0	31.0

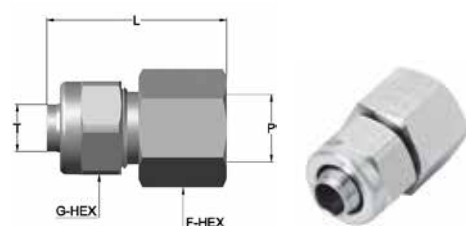

RCFX
Recto rosca hembra cilíndrica BSPP



CERTIFICACIÓN
FDA

RACORES RÁPIDOS EN ACERO INOX 316L

Ref.	Código	Ø Tubo	Rosca P	B	D	F-HEX	G-HEX	H-HEX	L1	L2
RLX 06G01	0606206220284	4x6	1/8"	5.8	13.8	10.0	13.0	14.0	21.5	24.9
RLX 06G02	0606206220285	4x6	1/4"	7.5	16.8	10.0	13.0	17.0	21.5	26.8
RLX 08G01	0606206220286	6x8	1/8"	5.8	13.8	12.0	14.0	14.0	23.7	26.0
RLX 08G02	0606206220287	6x8	1/4"	7.5	16.8	12.0	14.0	17.0	23.7	28.0
RLX 08G03	0606206220288	6x8	3/8"	7.5	20.3	12.0	14.0	20.6	23.7	28.5
RLX 10G01	0606206220289	8x10	1/8"	5.8	13.8	14.0	16.0	14.0	24.8	27.0
RLX 10G02	0606206220290	8x10	1/4"	7.5	16.8	14.0	16.0	17.0	24.8	29.0
RLX 10G03	0606206220291	8x10	3/8"	7.5	20.3	14.0	16.0	20.6	24.8	29.5
RLX 12G02	0606206220292	9x12	1/4"	7.5	16.8	16.0	19.0	17.0	27.6	30.3
RLX 12G03	0606206220293	9x12	3/8"	7.5	20.3	16.0	19.0	20.6	27.6	30.7
RLX 12G02	0606206220294	10x12	1/4"	7.5	16.8	16.0	19.0	17.0	27.6	30.3
RLX 12G03	0606206220295	10x12	3/8"	7.5	20.3	16.0	19.0	20.6	27.6	30.7
RLX 12G04	0606206220296	10x12	1/2"	10.0	23.3	16.0	19.0	22.0	27.6	33.8

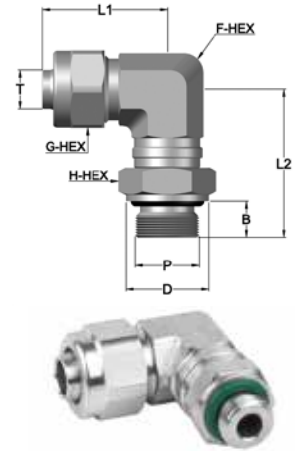

RLX-G
Codo 90° rosca macho cilíndrica BSPP giratoria

Ref.	Código	Ø Tubo	Rosca P	F-HEX	G-HEX	H-HEX	L1	L2
RCFMX 06G01	0606206220235	4x6	1/8"	14.0	13.0	14.0	36.8	25.0
RCFMX 06G02	0606206220236	4x6	1/4"	17.0	13.0	17.0	38.8	25.0
RCFMX 08G01	0606206220237	6x8	1/8"	16.0	14.0	16.0	37.8	26.0
RCFMX 08G02	0606206220238	6x8	1/4"	17.0	14.0	17.0	39.8	26.0
RCFMX 08G03	0606206220239	6x8	3/8"	20.6	14.0	20.6	39.8	26.0
RCFMX 10G02	0606206220240	8x10	1/4"	19.0	16.0	19.0	39.8	26.0
RCFMX 10G03	0606206220241	8x10	3/8"	20.6	16.0	20.6	29.8	26.0
RCFMX 12G02	0606206220242	9x12	1/4"	20.6	19.0	20.6	41.8	28.0
RCFMX 12G03	0606206220243	9x12	3/8"	20.6	19.0	20.6	41.8	28.0
RCFMX 12G02	0606206220244	10x12	1/4"	20.6	19.0	20.6	41.8	28.0
RCFMX 12G03	0606206220245	10x12	3/8"	20.6	19.0	20.6	41.8	28.0

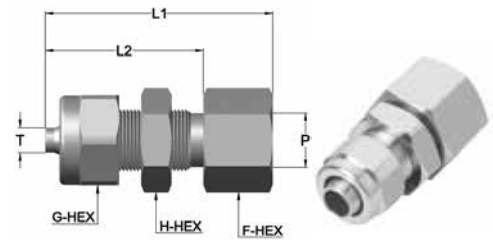

RCFMX-G
Recto Pasamuros rosca hembra cilíndrica BSPP

Ref.	Código	Ø Tubo	F-HEX	G-HEX	L
RUCX 0600	0606206220333	4x6	13.0	13.0	33.7
RUCX 0800	0606206220334	6x8	14.0	14.0	37.0
RUCX 1000	0606206220335	8x10	16.0	16.0	37.4
RUCX 1290	0606206220337	9x12	17.0	19.0	41.0
RUCX 1200	0606206220336	10x12	17.0	19.0	41.0



RUCX
Recto Tubo-Tubo

Ref.	Código	Ø Tubo 1	Ø Tubo 2	F-HEX	G1-HEX	G2-HEX	L
RUGX 0806	0606206220338	6x8	4x6	14.0	14.0	13.0	35.0
RUGX 1006	0606206220339	8x10	4x6	14.0	16.0	13.0	36.0
RUGX 1008	0606206220340	8x10	6x8	16.0	16.0	14.0	36.7
RUGX 1208	0606206220341	10x12	6x8	17.0	19.0	14.0	38.5
RUGX 1210	0606206220342	10x12	8x10	17.0	19.0	16.0	38.5

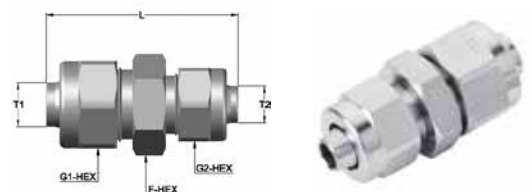

RUGX
Recto Reducción Tubo-Tubo

RACORES RÁPIDOS EN ACERO INOX 316L



CERTIFICACIÓN
FDA

Ref.	Código	Ø Tubo	F-HEX	G-HEX	H-HEX	L1	L2
RMMX 0600	0606206220298	4x6	14.0	13.0	14.0	25.0	44.4
RMMX 0800	0606206220299	6x8	16.0	14.0	16.0	26.0	47.3
RMMX 1000	0606206220300	8x10	19.0	16.0	19.0	26.0	47.7
RMMX 1290	0606206220302	9x12	20.6	19.0	20.6	28.0	51.5
RMMX 1200	0606206220301	10x12	20.6	19.0	20.6	28.0	51.5

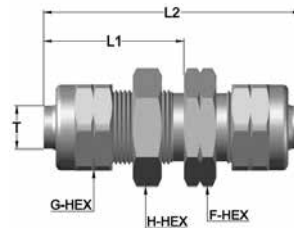

RMMX
Recto Tubo-Tubo Pasamuros

Ref.	Código	Ø Tubo	F-HEX	G-HEX	L
RULX 0600	0606206220343	4x6	10.0	13.0	21.5
RULX 0800	0606206220344	6x8	12.0	14.0	23.7
RULX 1000	0606206220345	8X10	14.0	16.0	24.8
RULX 1290	0606206220347	9X12	16.0	19.0	27.6
RULX 1200	0606206220346	10X12	16.0	19.0	27.6

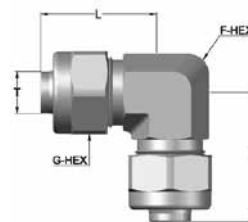

RULX
Codo 90° Tubo-Tubo

Ref.	Código	Ø Tubo	F-HEX	G-HEX	L
RUTX 0600	0606206220348	4x6	10.0	13.0	21.5
RUTX 0800	0606206220349	6x8	12.0	14.0	23.7
RUTX 1000	0606206220350	8X10	14.0	16.0	24.8
RUTX 1290	0606206220352	9X12	16.0	19.0	27.6
RUTX 1200	0606206220351	10X12	16.0	19.0	27.6

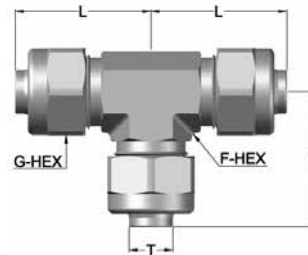

RUTX
"T" Tubo-Tubo-Tubo

Ref.	Código	Ø Tubo	Rosca P	B	D	F-HEX	G-HEX	H-HEX	L1	L2
RTX 06G01	0606206220320	4x6	1/8"	5.8	13.8	10.0	13.0	14.0	21.5	24.9
RTX 06G02	0606206220321	4x6	1/4"	7.5	16.8	10.0	13.0	17.0	21.5	26.8
RTX 08G01	0606206220322	6x8	1/8"	5.8	13.8	12.0	14.0	14.0	23.7	26.0
RTX 08G02	0606206220323	6x8	1/4"	7.5	16.8	12.0	14.0	17.0	23.7	28.0
RTX 08G03	0606206220324	6x8	3/8"	7.5	20.3	12.0	14.0	20.6	23.7	28.5
RTX 10G01	0606206220325	8x10	1/8"	5.8	13.8	14.0	16.0	14.0	24.8	27.0
RTX 10G02	0606206220326	8x10	1/4"	7.5	16.8	14.0	16.0	17.0	24.8	29.0
RTX 10G03	0606206220327	8x10	3/8"	7.5	20.3	14.0	16.0	20.6	24.8	29.5
RTX 129G02	0606206220328	9x12	1/4"	7.5	16.8	16.0	19.0	17.0	27.6	30.3
RTX 129G03	0606206220329	9x12	3/8"	7.5	20.3	16.0	19.0	20.6	27.6	30.7
RTX 12G02	0606206220330	10x12	1/4"	7.5	16.8	16.0	19.0	17.0	27.6	30.3
RTX 12G03	0606206220331	10x12	3/8"	7.5	20.3	16.0	19.0	20.6	27.6	30.7
RTX 12G04	0606206220332	10x12	1/2"	10.0	23.3	16.0	19.0	22.0	27.6	33.8

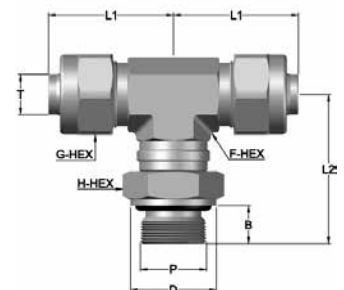

RTX-G
"T" Rosca central macho cilíndrica BSP giratoria



CERTIFICACIÓN
FDA

RACORES RÁPIDOS EN ACERO INOX 316L

Ref.	Código	Ø Tubo	Rosca P	B	D	F-HEX	G-HEX	H-HEX	L1	L2
RSTX 06G01	0606206220303	4x6	1/8"	5.8	13.8	10.0	13.0	14.0	21.5	24.9
RSTX 06G02	0606206220304	4x6	1/4"	7.5	16.8	10.0	13.0	17.0	21.5	26.8
RSTX 08G01	0606206220305	6x8	1/8"	5.8	13.8	12.0	14.0	14.0	23.7	26.0
RSTX 08G02	0606206220306	6x8	1/4"	7.5	16.8	12.0	14.0	17.0	23.7	28.0
RSTX 08G03	0606206220307	6x8	3/8"	7.5	20.3	12.0	14.0	20.6	23.7	28.5
RSTX 10G01	0606206220308	8x10	1/8"	5.8	13.8	14.0	16.0	14.0	24.8	27.0
RSTX 10G02	0606206220309	8x10	1/4"	7.5	16.8	14.0	16.0	17.0	24.8	29.0
RSTX 10G03	0606206220310	8x10	3/8"	7.5	20.3	14.0	16.0	20.6	24.8	29.5
RSTX 129G02	0606206220311	9x12	1/4"	7.5	16.8	16.0	19.0	17.0	27.6	30.3
RSTX 129G03	0606206220312	9x12	3/8"	7.5	20.3	16.0	19.0	20.6	27.6	30.7
RSTX 12G02	0606206220313	10x12	1/4"	7.5	16.8	16.0	19.0	17.0	27.6	30.3
RSTX 12G03	0606206220314	10x12	3/8"	7.5	20.3	16.0	19.0	20.6	27.6	30.7
RSTX 12G04	0606206220315	10x12	1/2"	10.0	23.3	16.0	19.0	22.0	27.6	33.8

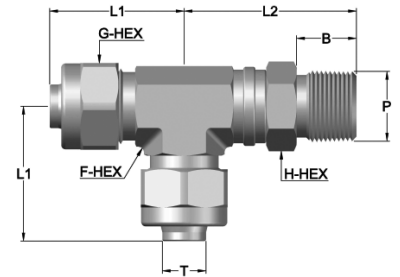

RSTX-G
"T" Rosca lateral macho cilíndrica BSPP giratoria

Ref.	Código	Ø Ext. Tubo	Rosca M	G-HEX	L
RTUX 0600	0606206220316	6 mm	M10X1	13.0	10.5
RTUX 0800	0606206220317	8 mm	M12X1	14.0	11.5
RTUX 1000	0606206220318	10 mm	M14X1	16.0	11.5
RTUX 1200	0606206220319	12 mm	M16X1	19.0	13.0

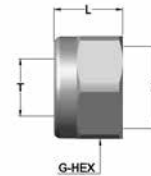

RTUX
Tuerca

Designación: Todas las roscas hembra son BSP cilíndrica.
Roscas macho: BSP cónica.
BSP cilíndrica.
En **R** la rosca de conexión es:

M5	01	02	03	04	05	06
M5x0,8	R-1/8"	R-1/4"	R-3/8"	R-1/2"	R-3/4"	R-1"

RACORES RÁPIDOS EN PFA



NEW!

CERTIFICACIÓN
FDA

Los racores rápidos en PFA están diseñados para aplicaciones con líquidos altamente agresivos y con un sistema de montaje extremadamente seguro. Su construcción garantiza su resistencia a la corrosión y la pureza en la conducción de los fluidos. Disponibles en una extensa gama de figuras para tubos en milímetros y tubos en pulgadas. Todos ellos en versiones con diferentes tipos de rosca. Diseñados para su uso con tubos PFA y PTFE.

El sistema de montaje consiste en la aplicación de calor sobre el tubo para abocardar la entrada del tubo en el racor. Este sistema utilizado en las aplicaciones más exigentes, garantiza una conexión totalmente estanca. Sus 2 biconos disponibles contruidos en PVDF y PPS garantizan excelentes ratios de temperatura y resistencia química.

FUNCIONES:

- . Químicamente inertes.
- . Contruidos con PFA virgen de alta pureza.
- . Aseguran la fiabilidad del conexionado en aplicaciones con fluidos altamente corrosivos.
- . Rápido montaje con sistema sonoro CLIC que informa que la tuerca ya está apretada en su posición idónea.
- . Extensa gama de figuras para tubos en mm y pulgadas.
- . Diseño resistente.

CARACTERÍSTICAS:

- . Cuerpo y tuerca: PFA.
- . Bicono cierre: PVDF estándar o PPS.
- . Presión de trabajo: 7 bar.
- . Temperatura máx. de trabajo: +150°C (PVDF) +240°C (PPS).
- . Conexiones: Roscas BSP o NPT (bajo pedido).
- . Montaje: es necesaria la herramienta de montaje para realizar el ensamblaje correctamente (ver croquis montaje).

APLICACIONES:

- . Salas blancas.
- . Semiconductores.
- . Biomédica.
- . Industria farmacéutica y química.
- . Cosméticos.
- . Industria alimentaria.
- . Petroquímica.

CERTIFICACIONES:

- . FDA.
- . ISO 9001.

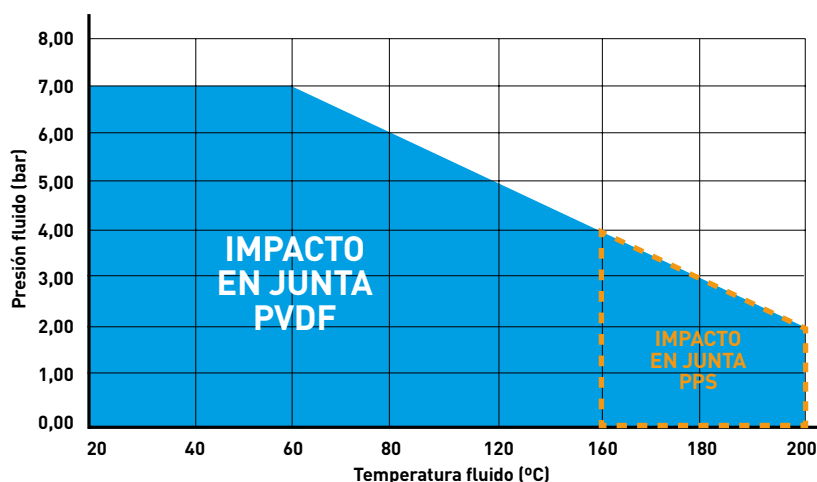
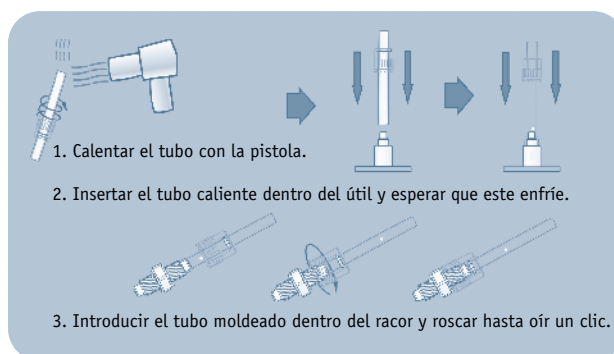
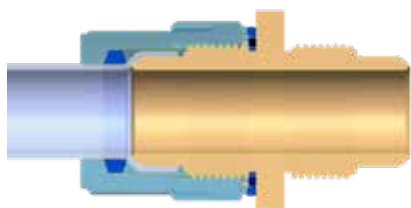
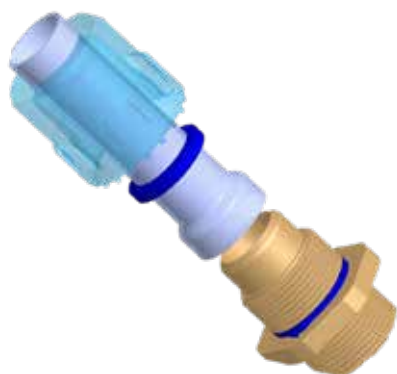



RACORES RÁPIDOS EN PFA



CONECTOR RECTO TUBO-MACHO BSPT

Ref.	Código	T	BSPT	HEX1	HEX2	(A)	(B)	C	ØD	ØE
PFARC 4601	A CONSULTAR	4X6	1/8"	16	20	38,2	23,2	9	4	3
PFARC 4602	A CONSULTAR	4X6	1/4"	16	20	42,2	23,2	13	4	6
PFARC 4603	A CONSULTAR	4X6	3/8"	16	20	42,2	23,2	13	4	10
PFARC 6801	A CONSULTAR	6x8	1/8"	19	23	42,4	27,4	9	6,3	3
PFARC 6802	A CONSULTAR	6x8	1/4"	19	23	46,4	27,4	13	6,3	6,3
PFARC 6803	A CONSULTAR	6x8	3/8"	19	23	46,4	27,4	13	6,3	10
PFARC 6804	A CONSULTAR	6x8	1/2"	19	23	50,2	27,4	16,8	6,3	12
PFARC 81002	A CONSULTAR	8x10	1/4"	19	23	46,4	27,4	13	8	6
PFARC 81003	A CONSULTAR	8x10	3/8"	19	23	46,4	27,4	13	8	10
PFARC 81004	A CONSULTAR	8x10	1/2"	19	23	50,2	27,4	16,8	8	12
PFARC 101202	A CONSULTAR	10x12	1/4"	24	29	53,3	33	13	10	6
PFARC 101203	A CONSULTAR	10x12	3/8"	24	29	53,3	33	13	10	10
PFARC 101204	A CONSULTAR	10x12	1/2"	24	29	57,1	33	16,8	10	12
PFARC 101205	A CONSULTAR	10x12	3/4"	24	29	57,4	33	17,1	10	16

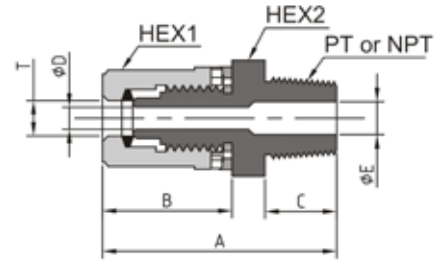

PFARC

CONECTOR EN CODO TUBO-MACHO BSPT

Ref.	Código	T	BSPT	HEX	(A)	(B)	ØC	ØD	W
PFARL 4601	A CONSULTAR	4X6	1/8"	16	33,7	18	4	3	10
PFARL 4602	A CONSULTAR	4X6	1/4"	16	33,7	22	4	6	10
PFARL 4603	A CONSULTAR	4X6	3/8"	16	33,7	22	4	10	10
PFARL 6801	A CONSULTAR	6X8	1/8"	19	39,9	20	6,3	3	14
PFARL 6802	A CONSULTAR	6X8	1/4"	19	39,9	24	6,3	6	14
PFARL 6803	A CONSULTAR	6X8	3/8"	19	39,9	24	6,3	10	14
PFARL 6804	A CONSULTAR	6X8	1/2"	19	39,9	27,8	6,3	12	14
PFARL 81002	A CONSULTAR	8X10	1/4"	19	39,9	24	8	6	14
PFARL 81003	A CONSULTAR	8X10	3/8"	19	39,9	24	8	10	14
PFARL 81004	A CONSULTAR	8X10	1/2"	19	39,9	27,8	8	12	14
PFARL 101202	A CONSULTAR	10X12	1/4"	24	48,5	26,5	10	6	18
PFARL 101203	A CONSULTAR	10X12	3/8"	24	48,5	26,5	10	10	18
PFARL 101204	A CONSULTAR	10X12	1/2"	24	48,5	30,3	10	12	18
PFARL 101205	A CONSULTAR	10X12	3/4"	24	48,5	30,6	10	16	18

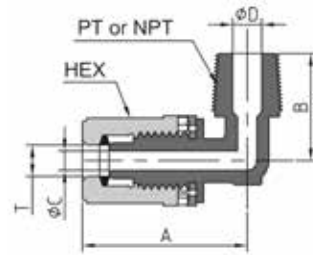

PFARL

CONECTOR TUBO-HEMERA BSPT

Ref.	Código	T	BSPT	HEX1	HEX2	(A)	ØE
PFARCF 4601	A CONSULTAR	4X6	1/8"	16	20	40,2	4
PFARCF 4602	A CONSULTAR	4X6	1/4"	16	20	43,2	4
PFARCF 4603	A CONSULTAR	4X6	3/8"	16	23	43,7	4
PFARCF 6801	A CONSULTAR	6X8	1/8"	19	23	44,4	6,3
PFARCF 6802	A CONSULTAR	6X8	1/4"	19	23	47,4	6,3
PFARCF 6803	A CONSULTAR	6X8	3/8"	19	23	47,9	6,3
PFARCF 81002	A CONSULTAR	8X10	1/4"	19	23	47,4	8
PFARCF 81003	A CONSULTAR	8X10	3/8"	19	23	47,9	8
PFARCF 81004	A CONSULTAR	8X10	1/2"	19	29	51,9	8
PFARCF 101202	A CONSULTAR	10X12	1/4"	24	29	54,3	10
PFARCF 101203	A CONSULTAR	10X12	3/8"	24	29	54,8	10
PFARCF 101204	A CONSULTAR	10X12	1/2"	24	29	58,8	10

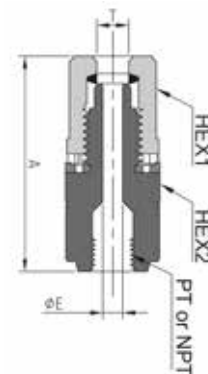

PFARCF

RACORES RÁPIDOS EN PFA



NEW!

CERTIFICACIÓN
FDA

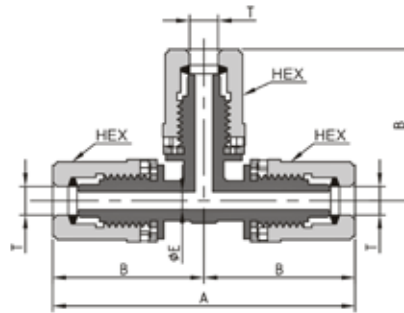

PFARUT

UNIÓN "T"

Ref.	Código	T	HEX	ØE	(A)	(B)	W
PFARUT 46	A CONSULTAR	4X6	16	4	67,4	33,7	10
PFARUT 68	A CONSULTAR	6X8	19	6,3	79,7	39,9	14
PFARUT 810	A CONSULTAR	8X10	19	8	79,7	39,9	14
PFARUT 1012	A CONSULTAR	10X12	24	10	97	48,5	18

UNIÓN TUBO-TUBO

Ref.	Código	T	HEX1	HEX2	(A)	ØE
PFARUC 46	A CONSULTAR	4X6	16	20	52,4	4
PFARUC 68	A CONSULTAR	6X8	19	23	60,7	6,3
PFARUC 810	A CONSULTAR	8X10	19	23	60,7	8
PFARUC 1012	A CONSULTAR	10X12	24	29	73,3	10

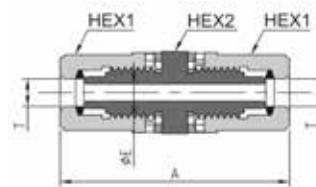

PFARUC

CODO TUBO-TUBO

Ref.	Código	T	HEX	(A)	ØC	W
PFARUL 46	A CONSULTAR	4X6	16	33,7	4	10
PFARUL 68	A CONSULTAR	6X8	19	39,9	6,3	14
PFARUL 810	A CONSULTAR	8X10	19	39,9	8	14
PFARUL 1012	A CONSULTAR	10X12	24	48,5	10	18

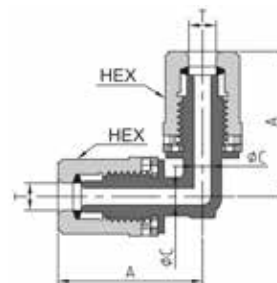

PFARUL

RECTO REDUCCIÓN TUBO-TUBO

Ref.	Código	T1	T2	HEX1	HEX2	HEX3	(A)	ØE1	ØE2
PFARUG 6846	A CONSULTAR	6X8	4X6	19	23	16	56,6	6,3	4
PFARUG 81046	A CONSULTAR	8X10	4X6	19	23	16	56,6	8	4
PFARUG 81068	A CONSULTAR	8X10	6X8	19	23	19	60,7	8	6,3
PFARUG 101246	A CONSULTAR	10X12	4X6	24	29	16	63,5	10	4
PFARUG 101268	A CONSULTAR	10X12	6X8	24	29	19	67,7	10	6,3
PFARUG 1012810	A CONSULTAR	10X12	8X10	24	29	19	67,7	10	8

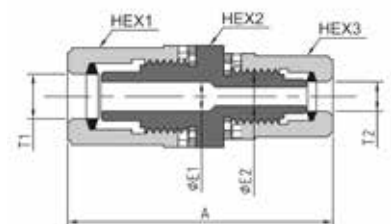

PFARUG



RACORES RÁPIDOS EN PFA

NEW!

CERTIFICACIÓN
FDA

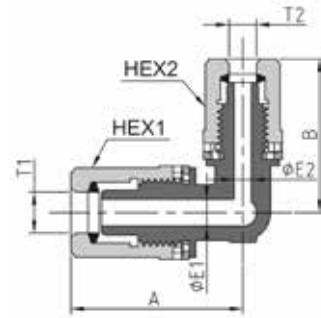

PFARULG

CODO REDUCCIÓN TUBO-TUBO

Ref.	Código	T1	T2	HEX1	HEX2	(A)	(B)	ØC	ØD	W
PFARULG 6846	A CONSULTAR	6X8	4X6	19	16	39,9	35,7	6,3	4	14
PFARULG 81046	A CONSULTAR	8X10	4X6	19	16	39,9	35,7	8	4	14
PFARULG 81068	A CONSULTAR	8X10	6X8	19	19	39,9	39,9	8	6,3	14
PFARULG 101246	A CONSULTAR	10X12	4X6	24	16	48,5	38,2	10	4	18
PFARULG 101268	A CONSULTAR	10X12	6X8	24	19	48,5	42,4	10	6,3	18
PFARULG 1012810	A CONSULTAR	10X12	8X10	24	19	48,5	42,4	10	8	18

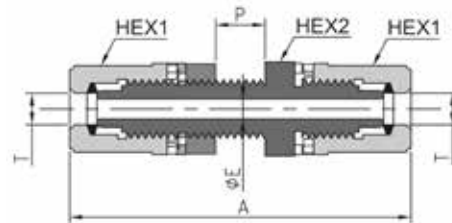

PFARMM

PASAMUROS TUBO-TUBO

Ref.	Código	T	ØM	P	HEX1	HEX2	(A)	ØE
PFARMM 46	A CONSULTAR	4X6	12,5	10	16	20	68,4	4
PFARMM 68	A CONSULTAR	6X8	18,5	10	19	23	76,7	6,3
PFARMM 810	A CONSULTAR	8X10	18,5	10	19	23	76,7	8
PFARMM 1012	A CONSULTAR	10X12	22,5	10	24	29	90,6	10

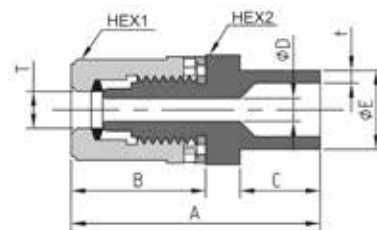

PFACJ

ADAPTADOR UNIÓN RACOR PULGADA A TUBO MÉTRICO

Ref.	Código	T	HEX1	HEX2	(A)	(B)	C	ØD	ØE	t
PFACJ 68	A CONSULTAR	6x8	19	23	54,4	27,4	21	6,3	9,53	1,6
PFACJ 1012	A CONSULTAR	10x12	24	29	65,3	33	25	10	12,7	1,6

TAPÓN

Ref.	Código	T	HEX1	HEX2	(A)	ØE
PFACAP 46	A CONSULTAR	4X6	16	20	29,2	4
PFACAP 68	A CONSULTAR	6X8	19	23	33,4	6,3
PFACAP 810	A CONSULTAR	8X10	19	23	33,4	8
PFACAP 1012	A CONSULTAR	10X12	24	29	40,3	10

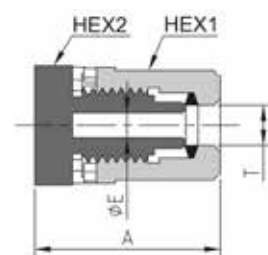

PFACAP



CONECTOR MACHO BSPT TUBO PASANTE

Ref.	Código	T	BSPT	HEX1	HEX2	(A)	(B)	C
PFARCP 4601	A CONSULTAR	4x6	1/8"	16	20	38,2	23,2	9
PFARCP 4602	A CONSULTAR	4x6	1/4"	16	20	42,2	23,2	13
PFARCP 4603	A CONSULTAR	4x6	3/8"	16	20	42,2	23,2	13
PFARCP 6802	A CONSULTAR	6X8	1/4"	19	23	46,4	27,4	13
PFARCP 6803	A CONSULTAR	6X8	3/8"	19	23	46,4	27,4	13
PFARCP 6804	A CONSULTAR	6X8	1/2"	19	23	50,2	27,4	16,8
PFARCP 81003	A CONSULTAR	8X10	3/8"	19	23	46,4	27,4	13
PFARCP 81004	A CONSULTAR	8X10	1/2"	19	23	50,2	27,4	16,8
PFARCP 101204	A CONSULTAR	10X12	1/2"	24	29	57,1	33	16,8
PFARCP 101205	A CONSULTAR	10X12	3/4"	24	29	57,4	33	17,1

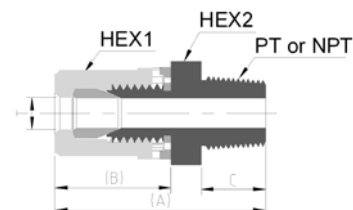

PFARCP

ANILLO COMPRESIÓN PVDF

Ref.	Código	T
PFARING 46	A CONSULTAR	4X6
PFARING 68	A CONSULTAR	6X8
PFARING 810	A CONSULTAR	8X10
PFARING 1012	A CONSULTAR	10X12

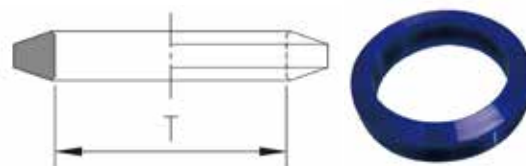

PFARING

BASE ÚTIL PREFORMAR

Ref.	Código	T
PFAB1	A CONSULTAR	4X6
	A CONSULTAR	6X8
	A CONSULTAR	8X10
PFAB2	A CONSULTAR	10X12

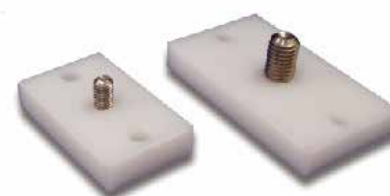

PFAB1

PFAB2

ÚTIL PREFORMAR

Ref.	Código	T
PFAUTIL 46	A CONSULTAR	4X6
PFAUTIL 68	A CONSULTAR	6X8
PFAUTIL 810	A CONSULTAR	8X10
PFAUTIL 1012	A CONSULTAR	10X12



PFAUTIL



VÁLVULAS DE CONTROL EN PFA

NEW!

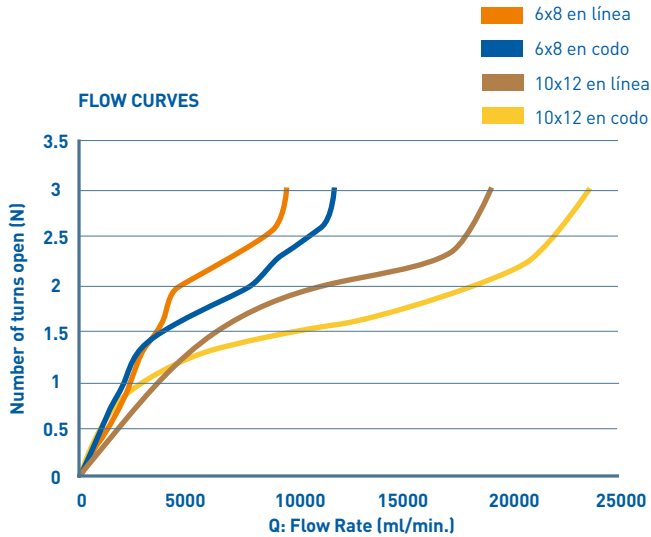

Método operativo	Manual
Conexión	Conexión Rápida
Presión máxima	7 bar
Temperatura máxima	100°C
Temperatura ambiente	60°C

Nº	Desc.	Material	Uds.
1	Cuerpo	PFA	1
2	Tuerca	PP	1
3	Férula	PTFE	1
4	Stem (Manilla)	PP	1
5	Stem (Medio)	PP	1
6	Stem (Aguja)	PFA	1
7	Cierre	PP	1
8	Tuerca Pasamuros	PFA	1
9	Tuerca (tubo)	PFA	1
10	Anillo de compresión	PVDF	1
11	Anillo de bloqueo	ETFE	1
12	Hex. Pomo	PPS	1

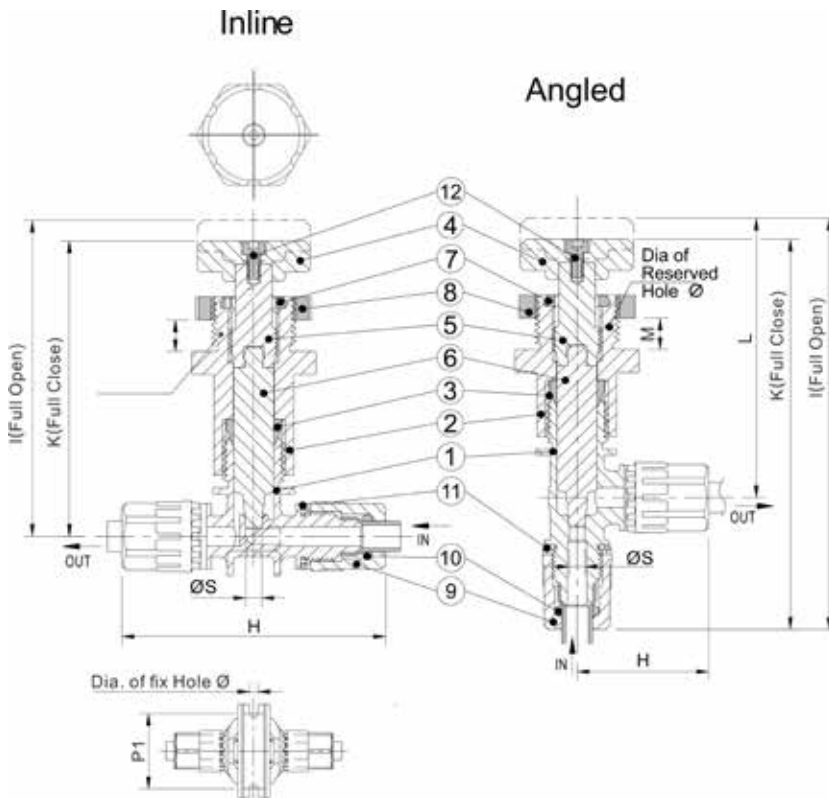

VÁLVULA ON-OFF

Ref.	Código	Modelo	Talla	ØS	I	K	J	H	L	P1	Ø orificio fijación	Ø orificio pasamuros	Tubo
PFAVC M1012	A CONSULTAR	EN LÍNEA	M12	8	114,5	107,3	-	106	-	48	7	38	10x12
PFAVC M68	A CONSULTAR		M8	5	100,8	94,3	-	84,7	-	40	4,5	29	6X8
PFAVCL M1012	A CONSULTAR	EN CODO	M12	8	152,9	145,7	27	53	99,9	-	-	38	10X12
PFAVCL M68	A CONSULTAR		M8	5	131,4	124,8	18	42,4	89,9	-	-	29	6X8

VÁLVULAS DE CONTROL EN PFA



NEW!

CERTIFICACIÓN
FDA

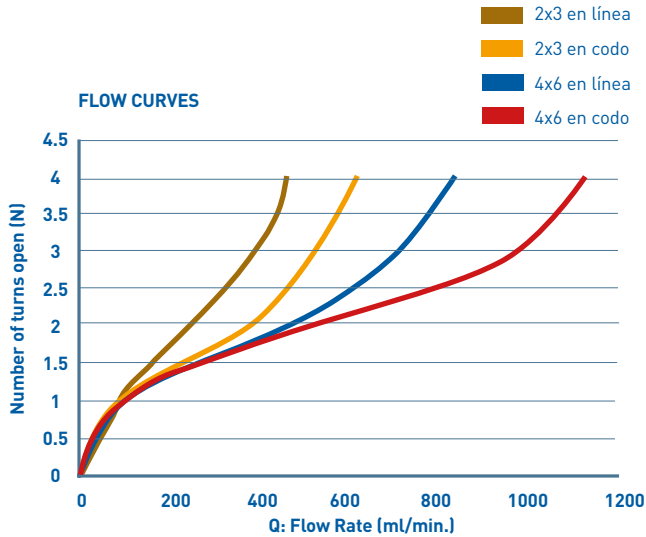

Método operativo	Manual
Conexión	Conexión Rápida
Presión máxima	7 bar
Temperatura máxima	100°C
Temperatura ambiente	60°C

Nº	Desc.	Material	Uds.
1	Cuerpo	PFA	1
2	Tuerca	PP	1
3	Férula	PTFE	1
4	Stem (Manilla)	PP	1
5	Stem (Medio)	PP	1
6	Stem (Aguja)	PFA	1
7	Cierre	PP	1
8	Tuerca Pasamuros	PFA	1
9	Tuerca (tubo)	PFA	1
10	Anillo de compresión	PVDF	1
11	Anillo de bloqueo	ETFE	1
12	Hex. Pomo	PPS	1

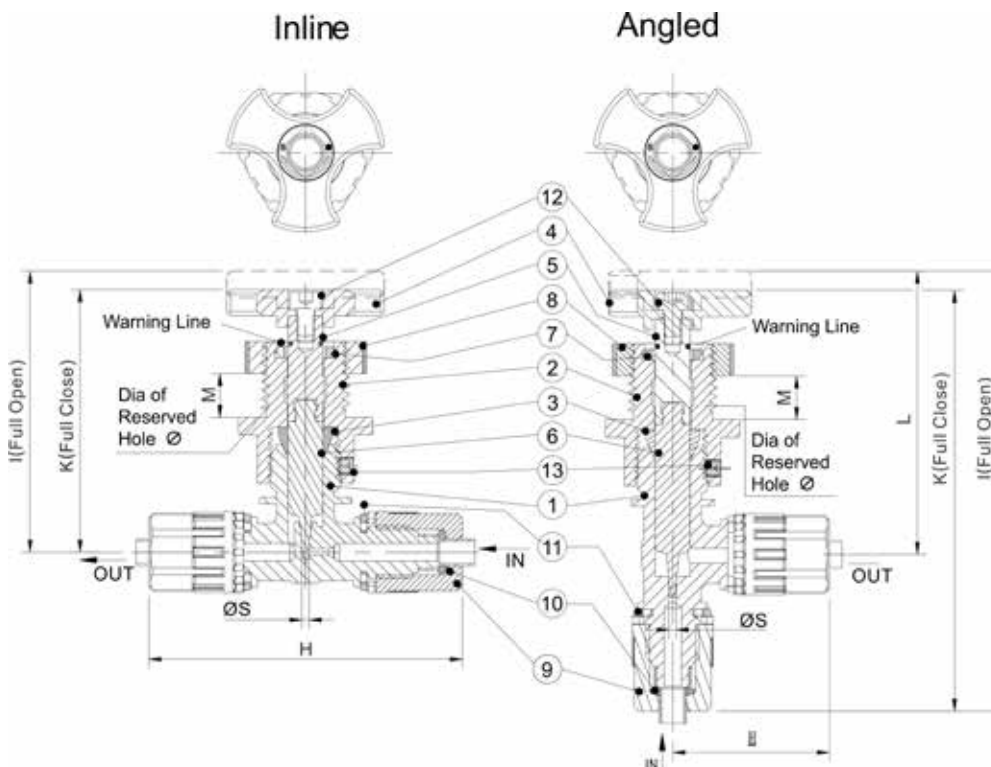

VÁLVULA AGUJA

Ref.	Código	Modelo	Talla	ØS	I	K	J	H	L	Ø orificio fijación	Tubo
PFAVR M46	A CONSULTAR	EN LÍNEA	M6	1,6	70,1	67,2	14	71,4	-	22	4x6
PFAVRL M46	A CONSULTAR	EN CODO	M6	1,6	98,5	95,6	14	35,7	70,3	22	4x6



CLEAN FITTING



CERTIFICACIÓN ISO 9001



Pídalo en cajas, conseguirá un mejor almacenaje.



La serie CLEAN FITTING ha sido diseñada para la conducción de fluidos y gases asegurando la máxima pureza en la conducción.

Disponibles en 2 versiones: Serie C con cuerpo y roscas en polipropileno y la serie CL con cuerpos polipropileno/inox y roscas inox. Racores fabricados con materia prima según norma FDA y libres de aceites y siliconas. Cuerpo en polipropileno translúcido para control visual fluido.

Ensamblados y empaquetados en SALA BLANCA con bolsas individuales que garantizan la máxima pureza y limpieza en cada pieza.

CARACTERÍSTICAS:

- . Presión máxima de trabajo: 7 bar a +20°C. (ver tabla presión Vs Temperatura)
- . Vacío: -750mmHg.
- . Rango temperatura: -20°C a +80°C.
- . Conexiones: Roscas BSPT y BSPP

NORMAS:

- . FDA 21 CFR 177.1520 (PP).
- . FDA 21 CFR 177.2600 (EPDM).

APLICACIONES:

- . Agua Pura.
- . Aire de limpieza.
- . Fluidos medicinales.
- . Industria alimentaria.
- . Filtración y purificación de agua.
- . Química en general.

SERIE C

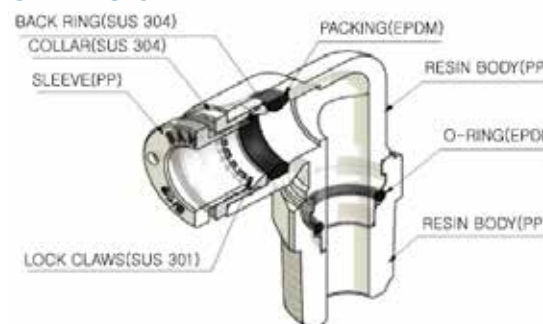

Presión Mpa

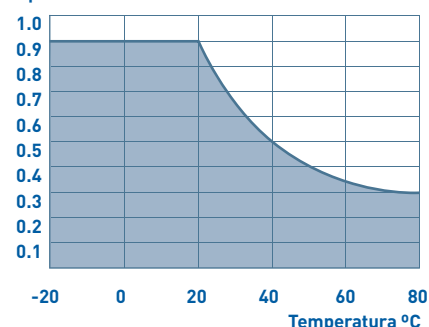

SERIE C POLIPROPILENO

Ref.	Código	Ø D	R	Ud./caja
CPC 04-01	0606106110114	4	1/8"	50
CPC 04-02	0606106110115	4	1/4"	50
CPC 06-01	0606106110116	6	1/8"	50
CPC 06-02	0606106110117	6	1/4"	50
CPC 08-01	0606106110118	8	1/8"	50
CPC 08-02	0606106110119	8	1/4"	50
CPC 10-02	0606106110120	10	1/4"	40
CPC 10-03	0606106110121	10	3/8"	25
CPC 10-04	0606106110122	10	1/2"	25
CPC 12-03	0606106110123	12	3/8"	25
CPC 12-04	0606106110124	12	1/2"	25



CPC
Recto Tubo-Rosca
macho cónica

Ref.	Código	Ø D1	Ø D2	Ud./caja
CPGJ 06-04	0606106110125	6	4	50
CPGJ 08-04	0606106110126	8	4	50
CPGJ 08-06	0606106110127	8	6	40
CPGJ 10-06	0606106110128	10	6	40
CPGJ 10-08	0606106110129	10	8	40
CPGJ 12-08	0606106110130	12	8	25
CPGJ 12-10	0606106110131	12	10	25

D1



D2

CPGJ
Reductor Tubo

Ref.	Código	Ø D	R	Ud./caja
CPL 04-01	0606106110132	4	1/8"	50
CPL 04-02	0606106110133	4	1/4"	50
CPL 06-01	0606106110134	6	1/8"	50
CPL 06-02	0606106110135	6	1/4"	40
CPL 08-01	0606106110136	8	1/8"	40
CPL 08-02	0606106110137	8	1/4"	40
CPL 10-02	0606106110138	10	1/4"	20
CPL 10-03	0606106110139	10	3/8"	20
CPL 10-04	0606106110140	10	1/2"	20
CPL 12-03	0606106110141	12	3/8"	20
CPL 12-04	0606106110142	12	1/2"	20



CPL
Codo 90° Tubo-Rosca
macho cónica

Ref.	Código	Ø D	R	Ud./caja
CPT 04-01	0606106110159	4	1/8"	50
CPT 04-02	0606106110160	4	1/4"	50
CPT 06-01	0606106110161	6	1/8"	40
CPT 06-02	0606106110162	6	1/4"	40
CPT 08-01	0606106110163	8	1/8"	40
CPT 08-02	0606106110164	8	1/4"	25
CPT 10-02	0606106110165	10	1/4"	20
CPT 10-03	0606106110166	10	3/8"	20
CPT 10-04	0606106110167	10	1/2"	20
CPT 12-03	0606106110168	12	3/8"	15
CPT 12-04	0606106110169	12	1/2"	15



CPT
"T" Tubo-Rosca
macho cónica-Tubo

SERIE C POLIPROPILENO

Ref.	Código	Ø D1	Ø D2	Ud./caja
CPUC 04	0606106110170	4	4	50
CPUC 06	0606106110171	6	6	40
CPUC 08	0606106110172	8	8	40
CPUC 10	0606106110173	10	10	25
CPUC 12	0606106110174	12	12	20



CPUC
Recto Tubo-Tubo

Ref.	Código	Ø D1	Ø D2	Ud./caja
CPUL 04	0606106110175	4	4	50
CPUL 06	0606106110176	6	6	40
CPUL 08	0606106110177	8	8	40
CPUL 10	0606106110178	10	10	25
CPUL 12	0606106110179	12	12	20



CPUL
Codo 90° Tubo-Tubo

Ref.	Código	Ø D1	Ø D2	Ø D3	Ud./caja
CPUT 04	0606106110180	4	4	4	50
CPUT 06	0606106110181	6	6	6	40
CPUT 08	0606106110182	8	8	8	30
CPUT 10	0606106110183	10	10	10	20
CPUT 12	0606106110184	12	12	12	15



CPUT
"T" Tubo-Tubo-Tubo

Ref.	Código	Ø D1	Ø D2	Ø D3	Ud./caja
CPY 04	0606106110185	4	4	4	50
CPY 06	0606106110186	6	6	6	40
CPY 08	0606106110187	8	8	8	30
CPY 10	0606106110188	10	10	10	20
CPY 12	0606106110189	12	12	12	15



CPY
Y Tubo-Tubo-Tubo

Ref.	Código	Ø D1	Ø D2	R	Ud./caja
CPST 04-01	0606106110148	4	4	1/8"	50
CPST 04-02	0606106110149	4	4	1/4"	40
CPST 06-01	0606106110150	6	6	1/8"	40
CPST 06-02	0606106110151	6	6	1/4"	40
CPST 08-01	0606106110152	8	8	1/8"	30
CPST 08-02	0606106110153	8	8	1/4"	25
CPST 10-02	0606106110154	10	10	1/4"	20
CPST 10-03	0606106110155	10	10	3/8"	20
CPST 10-04	0606106110156	10	10	1/2"	20
CPST 12-03	0606106110157	12	12	3/8"	15
CPST 12-04	0606106110158	12	12	1/2"	15



CPST
"T" Rosca macho cónica
-Tubo-Tubo

Ref.	Código	Ø D1	Ø D2	Ud./caja
CPMM 04	0606106110143	4	4	50
CPMM 06	0606106110144	6	6	40
CPMM 08	0606106110145	8	8	40
CPMM 10	0606106110146	10	10	25
CPMM 12	0606106110147	12	12	15



CPMM
Recto Tubo-Tubo
Pasamuros

CLEAN FITTING

SERIE CL

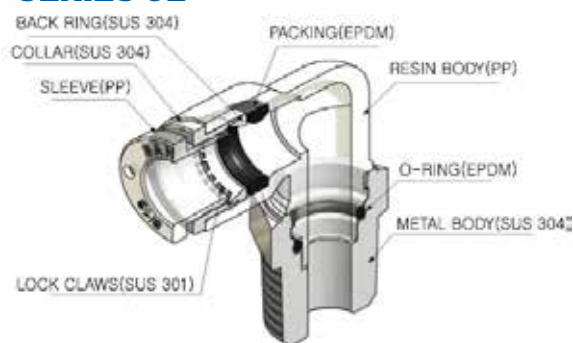

SERIE CL POLIPROPILENO-INOX

Ref.	Código	Ø D	R	Ud./caja
CLPC 04-01	0606106110001	4	1/8"	50
CLPC 04-02	0606106110002	4	1/4"	50
CLPC 06-01	0606106110006	6	1/8"	50
CLPC 06-02	0606106110007	6	1/4"	50
CLPC 08-01	0606106110011	8	1/8"	50
CLPC 08-02	0606106110012	8	1/4"	50
CLPC 10-02	0606106110015	10	1/4"	40
CLPC 10-03	0606106110016	10	3/8"	25
CLPC 10-04	0606106110017	10	1/2"	25
CLPC 12-03	0606106110021	12	3/8"	25
CLPC 12-04	0606106110022	12	1/2"	25



CLPC
Recto Tubo-Rosca
macho cónica

Ref.	Código	Ø D	R	Ud./caja
CLPC 04-M5	0606106110005	4	M5	50
CLPC 04-G01	0606106110003	4	1/8"	50
CLPC 04-G02	0606106110004	4	1/4"	50
CLPC 06-M5	0606106110010	6	M5	50
CLPC 06-G01	0606106110008	6	1/8"	50
CLPC 06-G02	0606106110009	6	1/4"	50
CLPC 08-G01	0606106110013	8	1/8"	50
CLPC 08-G02	0606106110014	8	1/4"	50
CLPC 10-G02	0606106110018	10	1/4"	40
CLPC 10-G03	0606106110019	10	3/8"	25
CLPC 10-G04	0606106110020	10	1/2"	25
CLPC 12-G03	0606106110023	12	3/8"	25
CLPC 12-G04	0606106110024	12	1/2"	25



CLPC-G
Recto Tubo-Rosca
macho cilíndrica



Pídale en cajas,
conseguirá un mejor
almacenaje.



CERTIFICACIÓN
FDA

NSF

CLEAN FITTING



CERTIFICACIÓN ISO 9001

Ref.	Código	Ø D	R	Ud./caja
CLPCF 04-M5	0606106110027	4	M5	50
CLPCF 04-G01	0606106110025	4	1/8"	100
CLPCF 04-G02	0606106110026	4	1/4"	100
CLPCF 06-G01	0606106110028	6	1/8"	100
CLPCF 06-G02	0606106110029	6	1/4"	50
CLPCF 08-G01	0606106110030	8	1/8"	100
CLPCF 08-G02	0606106110031	8	1/4"	50
CLPCF 10-G02	0606106110032	10	1/4"	50
CLPCF 10-G03	0606106110033	10	3/8"	25
CLPCF 10-G04	0606106110034	10	1/2"	25
CLPCF 12-G03	0606106110035	12	3/8"	25
CLPCF 12-G04	0606106110036	12	1/2"	25



CLPCF-G
Recto Tubo-Rosca
hembra cilíndrica

Ref.	Código	Ø D1	Ø D2	Ud./caja
CLPMM 04	0606106110061	4	4	50
CLPMM 06	0606106110062	6	6	40
CLPMM 08	0606106110063	8	8	40
CLPMM 10	0606106110064	10	10	25
CLPMM 12	0606106110065	12	12	20



CLPMM
Recto Tubo-Tubo
Pasamuros

Ref.	Código	Ø D	R	Ud./caja
CLPL 04-01	0606106110037	4	1/8"	50
CLPL 04-02	0606106110038	4	1/4"	50
CLPL 06-01	0606106110042	6	1/8"	40
CLPL 06-02	0606106110043	6	1/4"	40
CLPL 08-01	0606106110047	8	1/8"	40
CLPL 08-02	0606106110048	8	1/4"	40
CLPL 10-02	0606106110051	10	1/4"	20
CLPL 10-03	0606106110052	10	3/8"	20
CLPL 10-04	0606106110053	10	1/2"	20
CLPL 12-03	0606106110057	12	3/8"	20
CLPL 12-04	0606106110058	12	1/2"	20



CLPL
Codo 90° Tubo-Rosca
macho cónica

Ref.	Código	Ø D	R	Ud./caja
CLPL 04-M5	0606106110041	4	M5	50
CLPL 04-G01	0606106110039	4	1/8"	50
CLPL 04-G02	0606106110040	4	1/4"	50
CLPL 06-M5	0606106110046	6	M5	50
CLPL 06-G01	0606106110044	6	1/8"	40
CLPL 06-G02	0606106110045	6	1/4"	40
CLPL 08-G01	0606106110049	8	1/8"	40
CLPL 08-G02	0606106110050	8	1/4"	40
CLPL 10-G02	0606106110054	10	1/4"	20
CLPL 10-G03	0606106110055	10	3/8"	20
CLPL 10-G04	0606106110056	10	1/2"	20
CLPL 12-G03	0606106110059	12	3/8"	20
CLPL 12-G04	0606106110060	12	1/2"	20



CLPL-G
Codo 90° Tubo-Rosca
macho cilíndrica

Ref.	Código	Ø D	R	Ud./caja
CLPT 04-01	0606106110090	4	1/8"	50
CLPT 04-02	0606106110091	4	1/4"	50
CLPT 06-01	0606106110095	6	1/8"	40
CLPT 06-02	0606106110096	6	1/4"	40
CLPT 08-01	0606106110100	8	1/8"	40
CLPT 08-02	0606106110101	8	1/4"	25
CLPT 10-02	0606106110104	10	1/4"	20
CLPT 10-03	0606106110105	10	3/8"	20
CLPT 10-04	0606106110106	10	1/2"	20
CLPT 12-03	0606106110110	12	3/8"	15
CLPT 12-04	0606106110111	12	1/2"	15



CLPT
"T" Tubo-Rosca macho
cónica-Tubo

Ref.	Código	Ø D	R	Ud./caja
CLPT 04-M5	0606106110094	4	M5	50
CLPT 04-G01	0606106110092	4	1/8"	50
CLPT 04-G02	0606106110093	4	1/4"	50
CLPT 06-M5	0606106110099	6	M5	40
CLPT 06-G01	0606106110097	6	1/8"	40
CLPT 06-G02	0606106110098	6	1/4"	40
CLPT 08-G01	0606106110102	8	1/8"	25
CLPT 08-G02	0606106110103	8	1/4"	25
CLPT 10-G02	0606106110107	10	1/4"	20
CLPT 10-G03	0606106110108	10	3/8"	20
CLPT 10-G04	0606106110109	10	1/2"	20
CLPT 12-G03	0606106110112	12	3/8"	15
CLPT 12-G04	0606106110113	12	1/2"	15



CLPT-G
"T" Tubo-Rosca macho
cilíndrica-Tubo

Ref.	Código	Ø D	R	Ud./caja
CLPST 04-01	0606106110066	4	1/8"	50
CLPST 04-02	0606106110067	4	1/4"	40
CLPST 06-01	0606106110071	6	1/8"	40
CLPST 06-02	0606106110072	6	1/4"	40
CLPST 08-01	0606106110076	8	1/8"	30
CLPST 08-02	0606106110077	8	1/4"	25
CLPST 10-02	0606106110080	10	1/4"	20
CLPST 10-03	0606106110081	10	3/8"	20
CLPST 10-04	0606106110082	10	1/2"	20
CLPST 12-03	0606106110086	12	3/8"	15
CLPST 12-04	0606106110087	12	1/2"	15



CLPST
"T" Rosca macho
cónica Tubo-Tubo

Ref.	Código	Ø D	R	Ud./caja
CLPST 04-M5	0606106110070	4	M5	50
CLPST 04-G01	0606106110068	4	1/8"	50
CLPST 04-G02	0606106110069	4	1/4"	50
CLPST 06-M5	0606106110075	6	M5	40
CLPST 06-G01	0606106110073	6	1/8"	40
CLPST 06-G02	0606106110074	6	1/4"	40
CLPST 08-G01	0606106110078	8	1/8"	25
CLPST 08-G02	0606106110079	8	1/4"	25
CLPST 10-G02	0606106110083	10	1/4"	20
CLPST 10-G03	0606106110084	10	3/8"	20
CLPST 10-G04	0606106110085	10	1/2"	20
CLPST 12-G03	0606106110088	12	3/8"	15
CLPST 12-G04	0606106110089	12	1/2"	15



CLPST-G
"T" Rosca macho
cilíndrica-Tubo-Tubo

Conectores de alta calidad diseñados para asegurar un ajuste perfecto incluso en aplicaciones exigentes. Los moldes de fabricación aseguran figuras y roscas de una calidad excelente.

Estos accesorios fabricados con moldes de precisión están diseñados para asegurar la eliminación de puntos de fuga en aplicaciones para dispositivos médicos, instrumentos analíticos y conducción de aire. Presión máx. de trabajo: 6 bar.

OTROS MATERIALES DISPONIBLES:

- Nylon de alta resistencia (color negro o blanco).
- Policarbonato (color lila).
- PVDF.
- Versiones espiga-espiga, espiga-rosca y conexión LUER, todas en diferentes figuras.

APLICACIONES:

- Laboratorios en general.
- Instrumentos analíticos.
- Aplicaciones químicas y farmacéuticas.
- Equipos médicos.



DISEÑO QUE ASEGURA
PRECISIÓN Y SEGURIDAD
EN LA CONEXIÓN

ESPIGA RECTA TUBO-TUBO

Ref.	Código	Ø Int. Tubo (mm)	Pulgadas
HS2	0606406490010	1,6	1/16"
HS3	0606406490011	2,4	3/32"
HS4	0606406490012	3,2	1/8"
HS5	0606406490013	4,0	5/32"
HS6	0606406490015	4,8	3/16"
HS8	0606406490016	6,4	1/4"
HS12	0606406490009	9,5	3/8"



HS

ESPIGA CODO 90° TUBO-TUBO

Ref.	Código	Ø Interior Tubo (mm)	Pulgadas
HE2	0606406490002	1,6	1/16"
HE3	0606406490003	2,4	3/32"
HE4	0606406490004	3,2	1/8"
HE5	0606406490005	4,0	5/32"
HE6	0606406490007	4,8	3/16"
HE8	0606406490008	6,4	1/4"
HE12	0606406490001	9,5	3/8"



HE

ESPIGA "T" TUBO-TUBO-TUBO

Ref.	Código	Ø Int. Tubo (mm)	Pulgadas
HT2	0606406490035	1,6	1/16"
HT3	0606406490036	2,4	3/32"
HT4	0606406490037	3,2	1/8"
HT5	0606406490038	4,0	5/32"
HT6	0606406490040	4,8	3/16"
HT8	0606406490042	6,4	1/4"
HT12	0606406490034	9,5	3/8"



HT

ESPIGA "Y" TUBO-TUBO-TUBO

Ref.	Código	Ø Interior Tubo (mm)	Pulgadas
HY2	0606406490044	1,6	1/16"
HY3	0606406490045	2,4	3/32"
HY4	0606406490046	3,2	1/8"
HY5	0606406490047	4,0	5/32"
HY6	0606406490049	4,8	3/16"
HY8	0606406490051	6,4	1/4"
HY12	0606406490043	9,5	3/8"



HY

ESPIGA REDUCIDA TUBO-TUBO

Ref.	Código	Ø Int. Tubo (mm)	Pulgadas
HSR32	0606406490020	2,4 y 1,6	3/32" y 1/16"
HSR42	0606406490021	3,2 y 1,6	1/8" y 1/16"
HSR43	0606406490022	3,2 y 2,4	1/8" y 3/32"
HSR52	0606406490023	4,0 y 1,6	5/32" y 1/16"
HSR53	0606406490024	4,0 y 2,4	5/32" y 3/32"
HSR54	0606406490025	4,0 y 3,2	5/32" y 1/8"
HSR62	0606406490026	4,8 y 1,6	3/16" y 1/16"
HSR63	0606406490027	4,8 y 2,4	3/16" y 3/32"
HSR64	0606406490028	4,8 y 3,2	3/16" y 1/8"
HSR65	0606406490029	4,8 y 4,0	3/16" y 5/32"
HSR84	0606406490030	6,4 y 3,2	1/4" y 1/8"
HSR85	0606406490031	6,4 y 4,0	1/4" y 5/32"
HSR86	0606406490032	6,4 y 4,8	1/4" y 3/16"
HSR128	0606406490017	9,5 y 6,4	3/8" y 1/4"



HSR

ESPIGA A ROSCA MACHO NPT

Ref.	Código	Ø Interior Tubo (mm)	Rosca NPT
N4S3	0606406490057	2,4	1/8
N8S5	0606406490063	4,0	1/4
N8S8	0606406490064	6,4	1/4
N8S12	0606406490061	9,5	1/4



NS

ESPIGA CODO 20° A ROSCA MACHO NPT

Ref.	Código	Ø Interior Tubo (mm)	Rosca NPT
N4E4	0606406490055	3,2	1/8
N4E6	0606406490056	4,8	1/8
N8E8	0606406490060	6,4	1/4
N8E12	0606406490059	9,5	1/4



NE



ENCHUFE RÁPIDO INOX MINIATURA DN 5 CON DOBLE VÁLVULA (opcional simple válvula)

LUDECKE

CARACTERÍSTICAS:

- Cuerpo, válvulas y pulsador: acero Inox 1.4305 (ASTM 303).
- Muelle válvula y bolas: acero Inox 1.4310 y 1.4401.
- PN 35 bar.
- Caudal: 200 l/minuto.
- Temperatura: -15°C a +200°C.
- Junta: FKM (Opcional EPDM y FFKM)

APLICACIONES:

- Fluidos líquidos en industria farmacéutica, industria alimentaria, ingeniería química y médica, salas blancas y aplicaciones con alta demanda de higiene y de pureza.

BENEFICIOS:

- Válvula cierre en enchufe y adaptador.
- Diseño robusto, seguro y compacto.

ADVERTENCIA:

no intercambiable con DNS5 simple válvula.

Ref.	Código	Rosca	I	d	Ud. caja
ESME 18 AAB	0606506580045	G1/8"	36	16	25
ESME 14 AAB	0606506580041	G1/4"	38	16	25
ESME 38 AAB	0606506580049	G3/8"	38	16	25



d ESME AAB
Enchufe rosca macho.

Ref.	Código	Rosca	I	d	Ud. caja
ESME 18 IAB	0606506580046	G1/8"	38	16	25
ESME 14 IAB	0606506580042	G1/4"	38	16	25
ESME 38 IAB	0606506580050	G3/8"	39,5	16	25



d ESME IAB
Enchufe rosca hembra.

Ref.	Código	ID. Tubo	I	d	Ud. caja
ESME 4 TAB	0606506580056	4 mm	46,5	16	25
ESME 6 TAB	0606506580065	6 mm	46,5	16	25
ESME 8 TAB	0606506580071	8 mm	46,5	16	25
ESME 9 TAB	0606506580074	9 mm	46,5	16	25
ESME 10 TAB	0606506580037	10 mm	46,5	16	25



d ESME TAB
Enchufe espiga.

Ref.	Código	ID. Tubo	I	d	Ud. caja
ESME 5 TSVAB	0606506580060	5 mm	59,5	16	25
ESME 6 TSVAB	0606506580068	6 mm	59,5	16	25
ESME 8 TSVAB	0606506580072	8 mm	59,5	16	25



d ESME TSVAB
Enchufe espiga-pasamuros.

Ref.	Código	Tubo	I	d	Ud. caja
ESME 4 TQAB	0606506580057	4x6	43	16	25
ESME 6 TQAB	0606506580066	6x8	43	16	25



d ESME TQAB
Enchufe conexión rápida.

Ref.	Código	Tubo	I	d	Ud. caja
ESME 4 TQSVAB	0606506580058	4x6	54	16	25
ESME 6 TQSVAB	0606506580067	6x8	54	16	25



d ESME TQSVAB
Enchufe conexión rápida-pasamuros.

Ref.	Código	Rosca	I	Ud. caja
ESME 18 NAAB	0606506580047	G1/8"	40	25
ESME 14 NAAB	0606506580043	G1/4"	42	25
ESME 38 NAAB	0606506580051	G3/8"	42	25
ESME 1415 NAAB	0606506580039	M14x1,5	41,5	25



ESME NAAB
Adaptador rosca macho.

Ref.	Código	Rosca	I	Ud. caja
ESME 18 NIAB	0606506580048	G1/8"	41,5	25
ESME 14 NIAB	0606506580044	G1/4"	41,5	25
ESME 38 NIAB	0606506580052	G3/8"	41,5	25
ESME 101 NIAB	0606506580035	M10x1	41,5	25
ESME 1215 NIAB	0606506580038	M12x1,5	41,5	25
ESME 1415 NIAB	0606506580040	M14x1,5	41,5	25



ESME NIAB
Adaptador rosca hembra.

Ref.	Código	ID. Tubo	I	Ud. caja
ESME 4 SAB	0606506580053	4 mm	50	25
ESME 6 SAB	0606506580061	6 mm	50	25
ESME 8 SAB	0606506580069	8 mm	50,5	25
ESME 9 SAB	0606506580073	9 mm	50,5	25
ESME 10 SAB	0606506580036	10 mm	50	25



ESME SAB
Adaptador espiga.

Ref.	Código	ID. Tubo	I	Ud. caja
ESME 5 SSVAB	0606506580059	5 mm	63	25
ESME 6 SSVAB	0606506580064	6 mm	63	25
ESME 8 SSVAB	0606506580070	8 mm	63	25



ESME SSVAB
Adaptador espiga-pasamuros.

Ref.	Código	Tubo	I	Ud. caja
ESME 4 SQAB	0606506580054	4x6	47	25
ESME 6 SQAB	0606506580062	6x8	46,5	25



ESME SQAB
Adaptador conexión rápida.

Ref.	Código	Tubo	I	Ud. caja
ESME 4 SQSVAB	0606506580055	4x6	57,5	25
ESME 6 SQSVAB	0606506580063	6x8	58	25



ESME SQSVAB
Adaptador conexión rápida-pasamuros.

ENCHUFE RÁPIDO INOX DN 7.2 CON DOBLE Y SIMPLE VÁLVULA

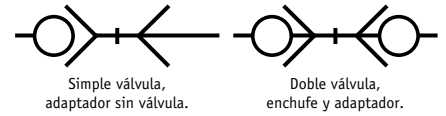

CARACTERÍSTICAS:

- . Cuerpo, válvulas y pulsador: acero Inox 1.4305 (ASTM 303).
- . Muelle válvula y bolas: Acero Inox 1.4310 y 1.4401
- . PN 35 bar.
- . Juntas FKM (Opcional EPDM / FFKM).
- . Caudal: 750l/m doble válvula y 1.200l/min simple válvula.
- . Temperatura: -15°C a +200°C.

APLICACIONES:

- . Fluidos líquidos en industria farmacéutica, industria alimentaria, ingeniería química y médica, salas blancas, aplicaciones con alta demanda de higiene y de pureza .
- . Aire comprimido y gases.

BENEFICIOS:

- . Válvula cierre en enchufe y opcional en adaptador.
- . Diseño robusto, seguro y compacto.



ESEG AAB
Enchufe rosca macho con válvula.



ESEG IAB
Enchufe rosca hembra con válvula.

Ref.	Código	Rosca	I	d	Ud. caja
ESEG 14 AAB	0606506580027	G1/4"	41	27	25
ESEG 38 AAB	0606506580029	G3/8"	42	27	25
ESEG 12 AAB	0606506580024	G1/2"	45	25	25

Ref.	Código	Rosca	I	d	Ud. caja
ESEG 14 IAB	0606506580028	G1/4"	41,5	27	25
ESEG 38 IAB	0606506580030	3/8"	42	27	25
ESEG 12 IAB	0606506580025	G1/2"	43,5	27	25



ESEG TAB
Enchufe espiga con válvula.

Ref.	Código	ID. Tubo	I	d	Ud. caja
ESEG 6 TAB	0606506580031	6 mm	60	27	25
ESEG 8 TAB	0606506580033	8 mm	60	27	25
ESEG 9 TAB	0606506580034	9 mm	60	27	25
ESEG 10 TAB	0606506580023	10 mm	60	27	25
ESEG 13 TAB	0606506580026	13 mm	60	27	25



ESE NAAB
Adaptador rosca macho con válvula.

Ref.	Código	Rosca	I	Ud. caja
ESE 14 NAAB	0606506580010	G1/4"	44,5	25
ESE 38 NAAB	0606506580014	G3/8"	45	25
ESE 12 NAAB	0606506580004	G1/2"	47	25



ESE NA
Adaptador rosca macho sin válvula.

Ref.	Código	Rosca	I	Ud. caja
ESE 14 NA	0606506580009	G1/4"	33	25
ESE 38 NA	0606506580013	G3/8"	33	25
ESE 12 NA	0606506580003	G1/2"	37	25



ESE NIAB
Adaptador rosca hembra con válvula.

Ref.	Código	Rosca	I	Ud. caja
ESE 14 NIAB	0606506580012	G1/4"	44	25
ESE 38 NIAB	0606506580016	G3/8"	44	25
ESE 12 NIAB	0606506580006	G1/2"	45,5	25



ESE NI
Adaptador rosca hembra sin válvula.

Ref.	Código	Rosca	I	Ud. caja
ESE 14 NI	0606506580011	G1/4"	32	25
ESE 38 NI	0606506580015	G3/8"	32	25
ESE 12 NI	0606506580005	G1/2"	35	25



ESE SAB
Adaptador espiga con válvula.

Ref.	Código	ID. Tubo	I	Ud. caja
ESE 6 SAB	0606506580018	6 mm	61,5	25
ESE 8 SAB	0606506580020	8 mm	61,5	25
ESE 9 SAB	0606506580022	9 mm	61,5	25
ESE 10 SAB	0606506580002	10 mm	61,5	25
ESE 13 SAB	0606506580008	13 mm	61,5	25



ESE S
Adaptador espiga sin válvula.

Ref.	Código	ID. Tubo	I	Ud. caja
ESE 6 S	0606506580017	6 mm	46	25
ESE 8 S	0606506580019	8 mm	46	25
ESE 9 S	0606506580021	9 mm	46	25
ESE 10 S	0606506580001	10 mm	46	25
ESE 13 S	0606506580007	13 mm	46	25

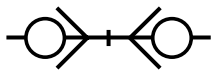

Doble válvula (punzón), enchufe y adaptador.



ENCHUFE RÁPIDO INOX

SERIE MLDB SISTEMA ANTIGOTEÓ

"BAJA PRESIÓN"



Hansen®

CARACTERÍSTICAS:

- . Cuerpo: acero Inox 316/316L resistente a la corrosión.
- . Muelle, válvula y bolas: acero Inox.
- . Juntas: estándar FKM. (Opcional EPDM, KALREZ y FFKM).
- . Temperatura de servicio: FKM: -20°C a +200°C. EPDM: -40°C a +150°C. KALREZ: -20°C a +275°C. FFKM: -15°C a +275°C.
- . Roscas: BSP cilíndricas (opcional NPT).

BENEFICIOS:

- . Excelente rendimiento con fluidos químicamente agresivos.
- . Diseñado con alta capacidad de caudal.
- . Con sistema seguridad en pulsador para evitar desconexiones involuntarias.
- . Diseño útil para una fácil limpieza y reemplazo de juntas.
- . Opcional herramienta y kits de juntas para recambio.
- . Opcionales anillos de colores para identificación líneas.

NORMAS:

- . Perfil conexión DANFOSS.
- . 2014/68/EU "PED".

APLICACIONES:

- . Conducción fluidos agresivos y corrosivos.
- . Refrigeración.
- . Industria farmacéutica, química y petroquímica.
- . Procesos industria alimentaria.
- . Ambientes corrosivos.
- . Perfumería, Destilerías, Aeronáutica e Industria Militar.

Rosca	DN	Presión máx. trabajo	Caudal*	Ref. enchufe	Código	Ref. adaptador	Código
hembra	mm	bar	l/min	parte hembra		parte macho	
1/4"	5.9	25	15	ML2DBS 25FBS	0606506570010	ML2DBP 25FBS	0606506570008
1/2"	11.5	25	73	ML4DBS 50FBS	0606506570013	ML4DBP 50FBS	0606506570012
3/4"	15.0	25	120	ML6DBS 75FBS	0606506570015	ML6DBP 75FBS	0606506570014
1"	18.5	25	200	ML8DBS 100FBS	0606506570019	ML8DBP 100FBS	0606506570018

* Caudal calculado con pérdida de carga 1 bar.



MLDB
Enchufe y adaptador.



Doble válvula, enchufe y adaptador.



ENCHUFE RÁPIDO ACERO

INOX AISI 316 SERIE MLFF

SISTEMA ANTIGOTEÓ "FLAT FACE"



Hansen®

CARACTERÍSTICAS:

- . Todas las partes metálicas son de acero Inox AISI 316 L.
- . Juntas: VITÓN (posibilidad EPDM, NBR+AU, HNBR).
- . Temperatura de servicio: -20°C a +200°C.
- . Ecológico.
- . Gran caudal.
- . Roscas BSP (opcional NPT).

PRINCIPAL APLICACIÓN:

- . Industria química y petroquímica, farmacéutica y agroalimentaria.
- . Paso de fluidos agresivos y corrosivos.

NORMAS:

- . ISO 16028 (intercambiable).

Rosca	DN	Presión máx. trabajo	Ref. enchufe	Código	Ref. adaptador	Código
hembra	mm	bar				
G1/4"	6,3	250	ML6FFS 25BS143	0606506570017	ML6FFP 25BS143	0606506570016
G3/8"	10	250	ML10FFS 37BS143	0606506570005	ML10FFP 37BS143	0606506570004
G1/2"	12	250	ML12FFS 50BS143	0606506570007	ML12FFP 50BS143	0606506570006
G3/4"	19	250	ML19FFS 75BS143	A CONSULTAR	ML19FFP 75BS143	A CONSULTAR
G1"	25	250	ML25FFS 100BS143	A CONSULTAR	ML25FFP 100BS143	A CONSULTAR



MLFF
Enchufe y adaptador.

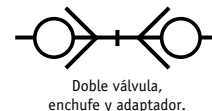

CARACTERÍSTICAS:

- . Cuerpo: Acero Zincado (Nuevo nivel de resistencia a la corrosión y recubrimiento libre de Nickel y solventes).
- . Muelle válvula y bolas: Acero Inox.
- . Juntas: Estándar NBR+AU (Opcional Vitón FKM/EPDM/HNBR).
- . Temperatura: NBR: -25°C a +100°C
FKM: -20°C a +200°C
EPDM: -40°C a +150°C
HNBR: -32°C a +150°C.
- . Roscas: BSP cilíndricas (opcional NPT)

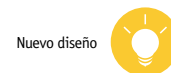

Consulte programa más amplio en www.accesfluid.com



NORMAS:

- . Perfil ISO 16028.
- . ROHS.
- . REACH.
- . ELV.
- . Medida 3/8" intercambiable con conectores HTMA.
- . PED 2014/68/EU.

APLICACIONES:

- . Agricultura y equipos hidráulicos.
- . Obra pública y Construcción.
- . Siderurgia.
- . Industria ferroviaria.
- . Sistemas de refrigeración con glicol.

BENEFICIOS:

- . Versión estándar con sistema "Sleeve Lock" para evitar desconexiones accidentales.
- . Mayor ratio de presión de trabajo y rotura que el resto de los fabricantes mundiales.
- . Nuevo diseño válvula interna que asegura el mayor caudal del mercado.
- . Nuevo recubrimiento que obtiene el mayor factor de durabilidad del mercado y ecológico.



FF
Enchufe y adaptador.

Rosca	Size (ISO)	DN	Presión máx. trabajo*	Caudal**	Pérdida fluido (1)	Inclusión Aire (2)	Ref. Enchufe	Código	Ref. Adaptador	Código
hembra	mm	mm	bar	l/min	ml-cc	ml-cc	parte hembra		parte macho	
G1/4"	6,3	6	400	18	0,004	0,007	6FFS 25BS	0606506510016	6FFP 25BS	0606506510015
G3/8"	10	8,6	400	40	0,006	0,010	10FFS 37BS	0606506510002	10FFP 37BS	0606506510001
G1/2"	12,5	11	400	77	0,012	0,013	12FFS 50BS	0606506510005	12FFP 50BS	0606506510003
G3/4"	19	15	400	114	0,034	0,015	19FFS 100BS	0606506510010	19FFP 100BS	0606506510009
G1"	25	18	400	184	0,032	0,033	25FFS 100BS	0606506510013	25FFP 100BS	0606506510011
G1 1/4"	-	22,1	300	260	0,170	0,053	32FFS 125BS	A CONSULTAR	32FFP 125BS	A CONSULTAR
G1 1/2"	-	30,1	300	450	0,265	0,445	40FFS 150BS	A CONSULTAR	40FFP 150BS	A CONSULTAR
G2"	-	39,2	300	700	0,390	0,260	50FFS 200BS	A CONSULTAR	50FFP 200BS	A CONSULTAR

Ref. Tapón plástico PVC	Código	Ref. Tapón plástico PVC	Código
para enchufe		para adaptador	
SDC6FF	A CONSULTAR	PDC6FF	A CONSULTAR
SDC10FF	A CONSULTAR	PDC10FF	A CONSULTAR
SDC12FF	A CONSULTAR	PDC12FF	A CONSULTAR
SDC19FF	A CONSULTAR	PDC19FF	A CONSULTAR
SDC25FF	A CONSULTAR	PDC25FF	A CONSULTAR



SDCFF
Tapón para enchufe.



PDCFF
Tapón para adaptador.

* Presión de trabajo 400 bar enchufe conectado y para aplicaciones estáticas (350 bar para ratio ISO para aplicaciones dinámicas).
** Caudal calculado con pérdida de carga 1bar.
(1) y (2) - Datos para cada conexión/desconexión.



RACORES TRI-CLAMP DIN 32676



ACCESFLUID certifica los procesos de fabricación de acuerdo con la norma DIN32676. El grado de rugosidad obtenido para la superficie interior es $Ra \leq 0,8\mu m$ y exterior $Ra \leq 1,6\mu m$. Calidad del acero inoxidable AISI 316.

CARACTERÍSTICAS:

- . Material TRI-CLAMP: AISI 316.
- . Material ABRAZADERAS: AISI 304 / AISI 316.
- . Valores Rugosidad: Interno $Ra \leq 0,8\mu m$ y Externo $Ra \leq 1,6\mu m$.
- . Presión máxima de trabajo: 16 bar (a 21°C).
- . Temperatura de trabajo: Ver tabla de juntas.
- . Juntas con certificación alimentaria.

NORMAS:

- . DIN 32676.
- . Anillo seguridad según EN-14420.

NEW!



CONSULTE PARA OTRAS FIGURAS,
MEDIDAS Y NORMAS
(3-A / BPE / ISO 1127 / IMPERIAL)



TRI-CLAMP ESPIGA ESTRIADA

Ref.	Código	OD Disco (mm)	ID Disco (mm)	OD Espiga (mm)
C13416DIN316	0505505560016	34	16	13,4
C13420DIN316	0505505560017	34	20	19,4
C15026DIN316	0505505560018	50.5	26	25,4
C15032DIN316	0505505560019	50.5	32	32,4
C15038DIN316	0505505560020	50.5	38	38,4
C16450DIN316	0505505560021	64	50	51,4
C19166DIN316	0505505560022	91	66	63,5
C110681DIN316	0505505560023	106	81	76,4
C1119100DIN316	0505505560024	119	100	101,8



Espiga estriada

TRI-CLAMP ESPIGA LISA

Ref.	Código	OD Disco (mm)	ID Disco (mm)	OD Espiga (mm)
C23416DIN316	0505505560025	34	16	13
C23420DIN316	0505505560026	34	20	19
C25026DIN316	0505505560027	50.5	26	25
C25032DIN316	0505505560028	50.5	32	32
C25038DIN316	0505505560029	50.5	38	38
C26450DIN316	0505505560030	64	50	51
C29166DIN316	0505505560031	91	66	63
C210681DIN316	0505505560032	106	81	76
C2119100DIN316	A CONSULTAR	119	100	101



Espiga lisa

TRI-CLAMP ESPIGA CON RECUBRIMIENTO EN PFA

Ref.	Código	OD Disco (mm)	ID Disco (mm)	OD Espiga (mm)
C15026DIN316-PFA	0505505560033	50.5	-	25,4
C15032DIN316-PFA	0505505560034	50.5	-	32,4
C15038DIN316-PFA	0505505560035	50.5	-	38,4
C16450DIN316-PFA	0505505560036	64	-	51,4
C19166DIN316-PFA	0505505560037	91	-	63,5
C110681DIN316-PFA	0505505560038	106	-	76,0
C1119100DIN316-PFA	0505505560039	119	-	101,8



Espiga con recubrimiento en PFA



RACORES TRI-CLAMP DIN 32676



TRI-CLAMP CODO 90° ESPIGA ESTRIADA

Ref.	Código	OD Disco (mm)	ID Disco (mm)	OD Espiga (mm)
C33416DIN316	0505505560040	34	16	13,4
C33420DIN316	0505505560041	34	20	19,4
C35026DIN316	0505505560042	50.5	26	25,4
C35032DIN316	0505505560043	50.5	32	32,4
C35038DIN316	0505505560044	50.5	38	38,4
C36450DIN316	0505505560045	64	50	51,4
C39166DIN316	0505505560046	91	66	63,5
C310681DIN316	0505505560047	106	81	76,4



Codo 90° espiga estriada

TRI-CLAMP CODO 45° ESPIGA ESTRIADA

Ref.	Código	OD Disco (mm)	ID Disco (mm)	OD Espiga (mm)
C43416DIN316	0505505560048	34	16	13,4
C43420DIN316	0505505560049	34	20	19,4
C45026DIN316	0505505560050	50.5	26	25,4
C45032DIN316	0505505560051	50.5	32	32,4
C45038DIN316	0505505560052	50.5	38	38,4
C46450DIN316	0505505560053	64	50	51,4
C49166DIN316	0505505560054	91	66	63,5
C410681DIN316	0505505560055	106	81	76,4



Codo 45° espiga estriada

TRI-CLAMP SOLDAR

Ref.	Código	OD Disco (mm)	ID Disco (mm)	Tubo soldar	Altura (mm)
C73416DIN316		34	16	16x19	28,5
C73420DIN316	0505505560056	34	20	20x23	28,5
C75026DIN316	0505505560057	50.5	26	26x29	28,5
C75032DIN316	0505505560058	50.5	32	32x35	28,5
C75038DIN316	0505505560059	50.5	38	38x41	28,5
C76450DIN316	0505505560060	64	50	50x53	28,5
C79166DIN316	0505505560061	91	66	66x70	28,5
C710681DIN316	0505505560062	106	81	81x85	28,5
C7119100DIN316	0505505560063	119	100	100x104	28,5



Soldar

TRI-CLAMP ROSCA MACHO CILÍNDRICA BSPP

Ref.	Código	OD Disco (mm)	ID Disco (mm)	Rosca M (BSPP)
C83416DIN316	0505505560056	34	16	1/2"
C83420DIN316	0505505560057	34	20	3/4"
C85026DIN316	0505505560058	50.5	26	1"
C85032DIN316	0505505560059	50.5	32	1-1/4"
C85038DIN316	0505505560060	50.5	38	1-1/2"
C86450DIN316	0505505560061	64	50	2"
C89166DIN316	0505505560062	91	66	2-1/2"
C810681DIN316	0505505560063	106	81	3"



Rosca macho cilíndrica BSPP

TRI-CLAMP ROSCA HEMBRA CILÍNDRICA BSPP

Ref.	Código	OD Disco (mm)	ID Disco (mm)	Rosca H (BSPP)
C93416DIN316	0505505560073	34	16	1/2"
C93420DIN316	0505505560074	34	20	3/4"
C95026DIN316	0505505560075	50.5	26	1"
C95032DIN316	0505505560076	50.5	32	1-1/4"
C95038DIN316	0505505560077	50.5	38	1-1/2"
C96450DIN316	0505505560078	64	50	2"
C99166DIN316	0505505560079	91	66	2-1/2"
C910681DIN316	0505505560080	106	81	3"



Rosca hembra cilíndrica BSPP



RACORES DIN 11851



NEW!

CARACTERÍSTICAS:

- . Material Racores Manguera: AISI 316L (1.4404).
- . Material Racores Soldar/Tuerca/Tapón: AISI 304 (1.4301).
- . Valores Rugosidad Interna: $Ra \leq 0,8\mu m$ - $Ra \leq 1,6\mu m$.
- . Presión máxima de trabajo: 16 bar (a 21°C).
- . Temperatura de trabajo: Ver tabla de juntas.
- . Los acoples no disponen de junta, se administran por separado.

NORMAS:

- . DIN 11851.
- . Anillo seguridad según EN-14420.
- . Posibilidad norma SMS1145 bajo pedido.

+ CONSULTAR OTRAS FIGURAS, MEDIDAS Y NORMAS.



RACOR HEMBRA SS316L ESPIGA ESTRIADA

Ref.	Código	DN	OD Espiga (mm)
HEE13DIN11851	0505505570002	15	13
HEE19DIN11851	0505505570003	20	19
HEE25DIN11851	0505505570004	25	25
HEE32DIN11851	0505505570005	32	32
HEE38DIN11851	0505505570006	40	38
HEE51DIN11851	0505505570007	50	51
HEE63DIN11851	0505505570008	65	63
HEE76DIN11851	0505505570009	80	76
HEE102DIN11851	0505505570010	100	102
HEE150DIN11851	0505505570011	150	150



RACOR HEMBRA SS316L ESPIGA LISA

Ref.	Código	DN	OD Espiga (mm)
HEL13DIN11851	0505505570012	15	13
HEL19DIN11851	0505505570013	20	19
HEL25DIN11851	0505505570014	25	25
HEL32DIN11851	0505505570015	32	32
HEL38DIN11851	0505505570016	40	38
HEL50DIN11851	0505505570017	50	50
HEL63DIN11851	0505505570018	65	63
HEL76DIN11851	0505505570019	80	76
HEL100DIN11851	0505505570020	100	100
HEL150DIN11851	0505505570021	150	150





RACORES DIN 11851



RACOR MACHO SS316L ESPIGA ESTRIADA

Ref.	Código	Rosca	DN	OD Espiga (mm)
MEE13DIN11851	0505505570022	RD34x1/8"	15	13
MEE19DIN11851	0505505570023	RD44x1/6"	20	19
MEE25DIN11851	0505505570024	RD52x1/6"	25	25
MEE32DIN11851	0505505570025	RD58x1/6"	32	32
MEE38DIN11851	0505505570026	RD65x1/6"	40	38
MEE51DIN11851	0505505570027	RD78x1/6"	50	51
MEE63DIN11851	0505505570028	RD95x1/6"	65	63
MEE76DIN11851	0505505570029	RD110x1/4"	80	76
MEE102DIN11851	0505505570030	RD130x1/4"	100	102
MEE150DIN11851	0505505570031	RD190x1/4"	150	150



MEE

RACOR MACHO SS316L ESPIGA LISA

Ref.	Código	Rosca	DN	OD Espiga (mm)
MEL13DIN11851	0505505570032	RD34x1/8"	15	13
MEL19DIN11851	0505505570033	RD44x1/6"	20	19
MEL25DIN11851	0505505570034	RD52x1/6"	25	25
MEL32DIN11851	0505505570035	RD58x1/6"	32	32
MEL38DIN11851	0505505570036	RD65x1/6"	40	38
MEL51DIN11851	0505505570037	RD78x1/6"	50	50
MEL63DIN11851	0505505570038	RD95x1/6"	65	63
MEL75DIN11851	0505505570039	RD110x1/4"	80	75
MEL102DIN11851	0505505570040	RD130x1/4"	100	100
MEL150DIN11851	0505505570041	RD190x1/4"	150	150



MEL

RACOR HEMBRA SS304 SOLDAR

Ref.	Código	DN	ID Tubo (mm)	OD Tubo (mm)
HS1621DIN11851	0505505570042	15	16	21
HS2025DIN11851	0505505570043	20	20	25
HS2631DIN11851	0505505570044	25	26	31
HS3237DIN11851	0505505570045	32	32	37
HS3843DIN11851	0505505570046	40	38	43
HS5055DIN11851	0505505570047	50	50	55
HS6672DIN11851	0505505570048	65	66	72
HS8187DIN11851	0505505570049	80	81	87
HS100106DIN11851	0505505570050	100	100	106
HS150157DIN11851	0505505570051	150	150	157



HS

RACOR MACHO SS304 SOLDAR

Ref.	Código	Rosca	DN	ID Tubo (mm)	OD Tubo (mm)
MS1621DIN11851	0505505570052	RD34x1/8"	15	16	21
MS2025DIN11851	0505505570053	RD44x1/6"	20	20	25
MS2631DIN11851	0505505570054	RD52x1/6"	25	26	31
MS3237DIN11851	0505505570055	RD58x1/6"	32	32	37
MS3843DIN11851	0505505570056	RD65x1/6"	40	38	43
MS5055DIN11851	0505505570057	RD78x1/6"	50	50	55
MS6672DIN11851	0505505570058	RD95x1/6"	65	66	72
MS8187DIN11851	0505505570059	RD110x1/4"	80	81	87
MS100106DIN11851	0505505570060	RD130x1/4"	100	100	106
MS150157DIN11851	0505505570061	RD190x1/4"	150	150	157



MS

RACORES DIN 11851



RACOR ADAPTADOR SS316 DIN11851 HEMBRA A CLAMP DIN32676

Ref.	Código	Rosca	DN	OD. Clamp
HDIN11851DN20CL34	0505505570062	RD44x1/6"	20	34
HDIN11851DN25CL50	0505505570063	RD52x1/6"	25	50,5
HDIN11851DN32CL50	0505505570064	RD58x1/6"	32	50,5
HDIN11851DN40CL50	0505505570065	RD65x1/6"	40	50,5
HDIN11851DN50CL64	0505505570066	RD78x1/6"	50	64
HDIN11851DN65CL91	0505505570067	RD95x1/6"	65	91
HDIN11851DN80CL106	0505505570068	RD110x1/4"	80	106



HDIN

RACOR ADAPTADOR SS316 DIN11851 MACHO A CLAMP DIN32676

Ref.	Código	Rosca	DN	OD. Clamp
MDIN11851DN20CL34	0505505570069	RD44x1/6"	20	34
MDIN11851DN25CL50	0505505570070	RD52x1/6"	25	50,5
MDIN11851DN32CL50	0505505570071	RD58x1/6"	32	50,5
MDIN11851DN40CL50	0505505570072	RD65x1/6"	40	50,5
MDIN11851DN50CL64	0505505570073	RD78x1/6"	50	64
MDIN11851DN65CL91	0505505570074	RD95x1/6"	65	91
MDIN11851DN80CL106	0505505570075	RD110x1/4"	80	106



MDIN

RACOR ADAPTADOR SS316 DIN11851 MACHO A HEMBRA IBC 60X6

Ref.	Código	Rosca M	DN	Rosca H
MDIN11851DN20H60X6	0505505570076	RD52x1/6"	25	S60X6
MDIN11851DN25H60X6	0505505570077	RD58x1/6"	32	S60X6
MDIN11851DN32H60X6	0505505570078	RD65x1/6"	40	S60X6
MDIN11851DN40H60X6	0505505570079	RD78x1/6"	50	S60X6



MDIN60X6

TUERCA HEMBRA SS304

Ref.	Código	DN	Rosca
TUHRD34DIN11851	0505505570080	15	RD34x1/8"
TUHRD44DIN11851	0505505570081	20	RD44x1/6"
TUHRD52DIN11851	0505505570082	25	RD52x1/6"
TUHRD58DIN11851	0505505570083	32	RD58x1/6"
TUHRD65DIN11851	0505505570084	40	RD65x1/6"
TUHRD78DIN11851	0505505570085	50	RD78x1/6"
TUHRD95DIN11851	0505505570086	65	RD95x1/6"
TUHRD110DIN11851	0505505570087	80	RD110x1/4"
TUHRD130DIN11851	0505505570088	100	RD130x1/4"
TUHRD190DIN11851	0505505570089	150	RD190x1/4"



TUHRD

TUERCA HEMBRA SS304

Ref.	Código	DN	Rosca
TAHRD34DIN11851	0505505570090	15	RD34x1/8"
TAHRD44DIN11851	0505505570091	20	RD44x1/6"
TAHRD52DIN11851	0505505570092	25	RD52x1/6"
TAHRD58DIN11851	0505505570093	32	RD58x1/6"
TAHRD65DIN11851	0505505570094	40	RD65x1/6"
TAHRD78DIN11851	0505505570095	50	RD78x1/6"
TAHRD95DIN11851	0505505570096	65	RD95x1/6"
TAHRD110DIN11851	0505505570097	80	RD110x1/4"
TAHRD130DIN11851	0505505570098	100	RD130x1/4"
TAHRD190DIN11851	0505505570099	150	RD190x1/4"



TAHRD

TAPÓN MACHO SS304

Ref.	Código	DN	Rosca
TAMRD34DIN11851	0505505570100	15	RD34x1/8"
TAMRD44DIN11851	0505505570101	20	RD44x1/6"
TAMRD52DIN11851	0505505570102	25	RD52x1/6"
TAMRD58DIN11851	0505505570103	32	RD58x1/6"
TAMRD65DIN11851	0505505570104	40	RD65x1/6"
TAMRD78DIN11851	0505505570105	50	RD78x1/6"
TAMRD95DIN11851	0505505570106	65	RD95x1/6"
TAMRD110DIN11851	0505505570107	80	RD110x1/4"
TAMRD130DIN11851	0505505570108	100	RD130x1/4"
TAMRD190DIN11851	0505505570109	150	RD190x1/4"



TAMRD

JUNTAS DIN11851

Material	Temperatura C°
MVQ (Silicona)	-100 a +250
NBR	-10 a +120
EPDM	-50 a +130
PTFE	-150 a +280

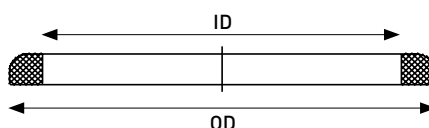

ID (mm)	OD (mm)	Espesor	DN	Ref. MVQ (Silicona)	Código	Ref. NBR	Código
18	26	4,5	15	J11851SIL15	A CONSULTAR	J11851NBR15	A CONSULTAR
23	33	4,5	20	J11851SIL20	A CONSULTAR	J11851NBR20	A CONSULTAR
30	40	5	25	J11851SIL25	A CONSULTAR	J11851NBR25	A CONSULTAR
36	46	5	32	J11851SIL32	A CONSULTAR	J11851NBR32	A CONSULTAR
42	52	5	40	J11851SIL40	A CONSULTAR	J11851NBR40	A CONSULTAR
54	64	5	50	J11851SIL50	A CONSULTAR	J11851NBR50	A CONSULTAR
71	81	5	65	J11851SIL65	A CONSULTAR	J11851NBR65	A CONSULTAR
85	95	5	80	J11851SIL80	A CONSULTAR	J11851NBR80	A CONSULTAR
104	114	5	100	J11851SIL100	A CONSULTAR	J11851NBR100	A CONSULTAR
155	167	7	150	J11851SIL150	A CONSULTAR	J11851NBR150	A CONSULTAR

ID (mm)	OD (mm)	Espesor	DN	Ref. EPDM	Código	Ref. PTFE	Código
18	26	4,5	15	J11851EPDM15	A CONSULTAR	J11851PTFE15	A CONSULTAR
23	33	4,5	20	J11851EPDM20	A CONSULTAR	J11851PTFE20	A CONSULTAR
30	40	5	25	J11851EPDM25	A CONSULTAR	J11851PTFE25	A CONSULTAR
36	46	5	32	J11851EPDM32	A CONSULTAR	J11851PTFE32	A CONSULTAR
42	52	5	40	J11851EPDM40	A CONSULTAR	J11851PTFE40	A CONSULTAR
54	64	5	50	J11851EPDM50	A CONSULTAR	J11851PTFE50	A CONSULTAR
71	81	5	65	J11851EPDM65	A CONSULTAR	J11851PTFE65	A CONSULTAR
85	95	5	80	J11851EPDM80	A CONSULTAR	J11851PTFE80	A CONSULTAR
104	114	5	100	J11851EPDM100	A CONSULTAR	J11851PTFE100	A CONSULTAR
155	167	7	150	J11851EPDM150	A CONSULTAR	J11851PTFE150	A CONSULTAR



VÁLVULAS DE DIAFRAGMA



Zona 1
(II 2G/D c T4)

CARACTERÍSTICAS:

- . Cuerpo en SS316L.
- . Actuador y asiento en SS304.
- . Superficie interna Ra ≤ 0.4 µm.
- . Superficie Electropulida, bajo pedido.
- . Material del diafragma: EPDM+PTFE (diafragma doble capa) y EPDM (opcional, consultar tamaños disponibles).
- . Temperatura: PTFE -10°C a +150°C.
- . Presión de trabajo: 0-10 bar.
- . Presión de control: 4,5 a 7 bar.

APLICACIONES:

- . Tanques de fermentación, recipiente de preparación, máquinas de llenado, equipos de esterilización, transferencias de fluidos asépticos, CIP/SIP.

SECTORES:

- . Farmacéutico, Alimentación y bebidas, Cosmético, Químico, ...



VDN



VDM



Válvulas de 3 vías asépticas tipo T



Válvulas de fondo de tanque

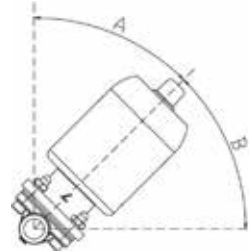

Válvulas de muestreo aséptico

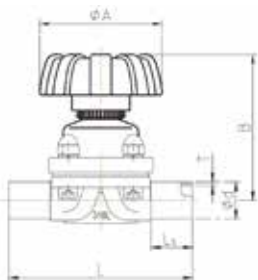

Tamaño	Ángulo de instalación	
	A	B
DN08	40,4°	49,6°
DN10	33,6°	56,4°
DN15	22,2°	67,8°
DN20	26,5°	63,5°
DN25	29,9°	60,1°
DN40	27,2°	62,8°
DN50	30,1°	59,9°

Diafragma manual - Conexión soldada							ASME-BPE	SMS3008	JIS-G3447	ISO-1127	DIN-11850				DIN-11866							
Tamaño	Diafragma	Ø A	B	Ls	L	Ø d x T	Ø d x T	Ø d x T	Ø d x T	Ø d x T	- 0	- 1	- 2	- 3	A	B						
DN8	8	40	64	20	72	6,35 x 0,89	-	-	-	-	-	-	-	-	-	-						
DN10	8	40	64	20	72	9,53 x 0,89	-	-	-	-	-	-	-	-	-	-						
DN15	8	50	64	20	72	12,70 x 1,65	-	-	-	-	-	-	-	-	-	-						
	10	65	85	29	108	-	-	-	21,3 x 1,6	18 x 1,5	18 x 1,0	19 x 1,5	20 x 2	19 x 1,5	21,3 x 1,6							
DN20	10	65	85	29	108	19,05 x 1,65	-	-	-	-	-	-	-	-	-	-						
	25	85	102	26	120	-	-	-	26,9 x 1,6	22 x 1,5	22 x 1,0	23 x 1,5	24 x 2	23 x 1,5	26,9 x 1,6							
DN25	25	85	102	26	120	25,4 x 1,65	25,0 x 1,2	25,4 x 1,2	33,7 x 2	28 x 1,5	28 x 1,0	29 x 1,5	30 x 2	29 x 1,5	33,7 x 2							
DN40	40	105	115	30	153	38,1 x 1,65	38,0 x 1,2	38,1 x 1,2	48,3 x 2	40 x 1,5	40 x 1,0	41 x 1,5	43 x 2	41 x 1,5	48,3 x 2							
DN50	50	125	133	30	173	50,8 x 1,65	51,0 x 1,2	50,8 x 1,5	60,3 x 2	52 x 1,5	52 x 1,0	53 x 1,5	54 x 2	53 x 1,5	60,3 x 2							
Diafragma manual - Conex. Tri-clamp							ASME-BPE		ASME-BPE / EN558-1 Series 7		SMS3008		JIS-G3447		ISO-1127		DIN-11850					
Tamaño	Diafragma	Ø A	B	Ls	Ø d1	Ø d2	L1	Ø d1	Ø d2	L1	Ø d1	Ø d2	L1	Ø d1	Ø d2	L1	Ø d1	Ø d2	L1			
DN8	8	40	64	15,5	4,57	25	63,5	-	-	-	-	-	-	-	-	-	-	-	-			
DN10	8	40	64	15,5	7,75	25	63,5	-	-	-	-	-	-	-	-	-	-	-	-			
DN15	8	50	64	15,5	9,4	25	63,5	9,4	25	108	-	-	-	-	-	-	-	-	-			
	10	65	85	34	-	-	-	-	-	-	-	-	-	18,1	50,5	108	16,0	34	108			
DN20	10	65	85	34	15,75	25	101,6	15,75	25	117	15,75	25	117	-	-	-	-	-	-			
	25	85	102	30	-	-	-	-	-	-	-	-	-	23,7	50,5	117	20,0	34	117			
DN25	25	85	102	30	22,1	50,5	114,3	22,1	50,5	127	22,6	50,5	127	23	50,5	127	29,7	50,5	127	26,0	50,5	127
DN40	40	105	115	33	34,8	50,5	139,7	34,8	50,5	159	35,6	50,5	159	35,7	50,5	159	44,3	64	159	38,0	50,5	159
DN50	50	125	133	39	47,5	50,5	158,8	47,5	64	190	48,6	64	190	47,8	64	190	56,3	77,5	190	50,0	64	190



TABLA VALORES Kv (m³/h, medio: agua)

TAMAÑO	NEUMÁTICA	MANUAL
DN15	1,59	1,14
DN20	5,72	5,57
DN25	10,67	11,42
DN40	21,92	17,52
DN50	37,79	34,48

Diafragma neumático - Conexión soldada										DIN-11850				DIN-11866		
Tamaño	Diafragma	Actuador	Ø A	B	Ls	L	ASME-BPE Ø d x T	SMS3008 Ø d x T	JIS-G3447 Ø d x T	ISO-1127 Ø d x T	- 0 Ø d x T	- 1 Ø d x T	- 2 Ø d x T	- 3 Ø d x T	A Ø d x T	B Ø d x T
DN8	8	42	47	85	20	72	6,35 x 0,89	-	-	-	-	-	-	-	-	-
DN10	8	42	47	85	20	72	9,53 x 0,89	-	-	-	-	-	-	-	-	-
DN15	8	50	57	106	20	72	12,70 x 1,65	-	-	-	-	-	-	-	-	-
	10	57	65	134	29	108	-	-	-	21,3 x 1,6	18 x 1,5	18 x 1,0	19 x 1,5	20 x 2	19 x 1,5	21,3 x 1,6
DN20	10	57	65	134	29	108	19,05 x 1,65	-	-	-	-	-	-	-	-	-
	25	80	88	170	26	120	-	-	-	26,9 x 1,6	22 x 1,5	22 x 1,0	23 x 1,5	24 x 2	23 x 1,5	26,9 x 1,6
DN25	25	80	88	170	26	120	25,4 x 1,65	25,0 x 1,2	25,4 x 1,2	33,7 x 2	28 x 1,5	28 x 1,0	29 x 1,5	30 x 2	29 x 1,5	33,7 x 2
DN40	40	105	109	196	30	153	38,1 x 1,65	38,0 x 1,2	38,1 x 1,2	48,3 x 2	40 x 1,5	40 x 1,0	41 x 1,5	43 x 2	41 x 1,5	48,3 x 2
DN50	50	125	129	226	30	173	50,8 x 1,65	51,0 x 1,2	50,8 x 1,5	60,3 x 2	52 x 1,5	52 x 1,0	53 x 1,5	54 x 2	53 x 1,5	60,3 x 2

Diafragma neumático - Conexión Tri-clamp										ASME-BPE / EN558-1 Series 7			SMS3008			JIS-G3447			ISO-1127			DIN-11850		
Tam.	Diafrag.	Actuador	Ø A	B	Ls	Ø d1	Ø d2	L1	Ø d1	Ø d2	L1	Ø d1	Ø d2	L1	Ø d1	Ø d2	L1	Ø d1	Ø d2	L1	Ø d1	Ø d2	L1	
DN8	8	42	47	85	15,5	4,57	25	63,5	-	-	-	-	-	-	-	-	-	-	-	-	-	-	-	-
DN10	8	42	47	85	15,5	7,75	25	63,5	-	-	-	-	-	-	-	-	-	-	-	-	-	-	-	-
DN15	8	50	57	106	15,5	9,4	25	63,5	9,4	25	108	-	-	-	-	-	-	-	-	-	-	-	-	-
	10	57	65	134	34	-	-	-	-	-	-	-	-	-	-	-	-	18,1	50,5	108	16,0	34	108	
DN20	10	57	65	134	34	15,75	25	101,6	15,75	25	117	15,75	25	117	-	-	-	-	-	-	-	-	-	-
	25	80	88	170	30	-	-	-	-	-	-	-	-	-	-	-	-	23,7	50,5	117	20,0	34	117	
DN25	25	80	88	170	30	22,1	50,5	114,3	22,1	50,5	127	22,6	50,5	127	23	50,5	127	29,7	50,5	127	26,0	50,5	127	
DN40	40	105	109	196	33	34,8	50,5	139,7	34,8	50,5	159	35,6	50,5	159	35,7	50,5	159	44,3	64	159	38,0	50,5	159	
DN50	50	125	129	226	39	47,5	64	158,8	47,5	64	190	48,6	64	190	47,8	64	190	56,3	77,5	190	50,0	64	190	

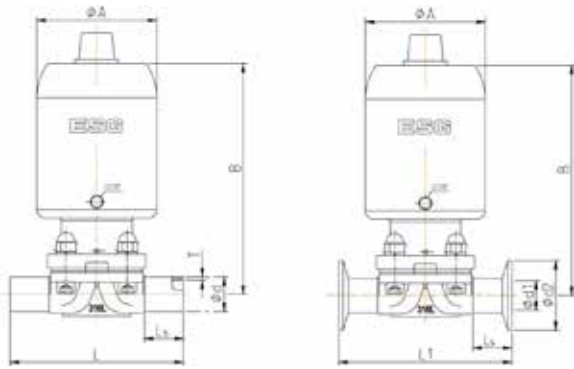
CÓMO PEDIR SU REFERENCIA (ver tablas con información de modelos estándar):

Indicar Serie, Accionamiento, -, Extremos, -, DN, -, Diafragma, -, Función, -, Pulido.

<p>Serie</p> <p>VD</p>	<p>Accionamiento</p> <p>M: Manual N: Neumática</p>	<p>Extremos</p> <p>T1: TRI-CLAMP ASME-BPE T2: TRI-CLAMP SMS3008 T3: TRI-CLAMP JIS-G3447 T4: TRI-CLAMP ISO1127 T5: TRI-CLAMP DIN11850 T6: TRI-CLAMP ASME-BPE-EN558-1</p> <p>S1: SOLDADO ASME-BPE S2: SOLDADO SMS3008 S3: SOLDADO JIS-G3447 S4: SOLDADO ISO1127 / DIN11866 B S5: SOLDADO DIN11850-0 S6: SOLDADO DIN11850-1 S7: SOLDADO DIN11850-2/DIN11866 A S8: SOLDADO DIN11850-3</p>	<p>DN</p> <p>Ø8: 8mm Ø10: 10mm Ø15: 15mm Ø20: 20mm Ø25: 25mm Ø40: 40mm Ø50: 50mm</p>	<p>Diafragma</p> <p>MØ8: Diafragma 8 MØ10: Diafragma 10 MØ25: Diafragma 25 MØ40: Diafragma 40 MØ50: Diafragma 50</p>	<p>Función</p> <p>O: Accionamiento Manual A: Simple Efecto N.C.</p>	<p>Pulido</p> <p>M: Estándar E: Electro pulido</p>
--------------------------------------	---	--	---	---	--	---

NEW!

VÁLVULAS DE DIAFRAGMA CON CONTROL PROPORCIONAL NEUMÁTICO

ESG®

CERTIFICACIÓN
FDA

USP Class VI



ATEX

Zona 2
(IIIG Ex nA IIC T4 Gc)

CARACTERÍSTICAS:

- . Cuerpo en SS316L.
- . Actuador y asiento en SS304.
- . Superficie interna Ra ≤ 0.4 μm, Electropulido.
- . Material del diafragma: EPDM+PTFE (diafragma doble capa) y EPDM (opcional, consultar tamaños disponibles).
- . Temperatura: PTFE -10°C a +150°C.
- . Presión de trabajo: 0-10 bar.
- . Voltaje: 24 VDC.
- . Potencia: < 5W.
- . Señal de entrada: 0/4-20 mA, 0-5/10V.
- . Señal de salida: 0/4-20 mA, 0-5/10V.
- . Material controlador: PA6+GF30+PC.
- . Presión de control: 3 a 7 bar.
- . Temperatura ambiente: 0-60°C.
- . Nivel de protección IP65.
- . Explosión-proof: Ex nA IIC T4.

APLICACIONES:

- . Tanques de fermentación, recipiente de preparación, máquinas de llenado, equipos de esterilización, transferencias de fluidos asépticos, CIP/SIP.

SECTORES:

- . Farmacéutico, Alimentación y bebidas, Cosmético, Químico, ...

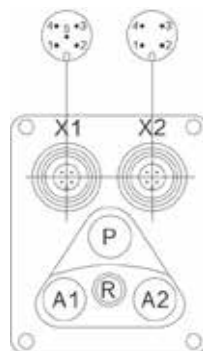

VDP

TERMINAL ELÉCTRICO

Etiqueta Puerto	Terminal	Descripción	Tipo de señal
X1	1	Señal analógica salida +	0/4-20 mA o 0-5/10 V
	2	Alarma de posición incorrecta	Alto nivel
	3	Habilitación de posición segura	Alto nivel
	4	Disparo de posición segura	Alto nivel
	5	Señal común (Tierra)	Tierra
X2	1	Potencia +	+24V
	2	Potencia (Tierra)	Tierra
	3	Señal establecida de entrada (+)	0/4-20 mA o 0-5/10 V
	4	Señal establecida de entrada (Tierra)	Tierra

TERMINAL NEUMÁTICO

Etiqueta Puerto	Descripción
P	Entrada aire
A1	Puerto pilotaje 1
A2	Puerto pilotaje 2
R	Puerto escape

VENTAJAS:

- . Sistema patentado de guiado doble de vástago.
- . El diseño de asiento de resorte patentado permite un mantenimiento sin esfuerzo.
- . El diseño patentado permite que el vástago y el núcleo de la válvula se conecten a través de la superficie cóncava interna y, por lo tanto, garantiza un sellado hermético.
- . Se puede instalar en cualquier ubicación de tubería. La dirección del flujo medio no afecta la apertura/cierre de la válvula.
- . Los diafragmas ESG PTFE son capaces de soportar 1 millón de ciclos de prueba de flexión.
- . Los diafragmas ESG han pasado las certificaciones FDA y USP.
- . Las válvulas de diafragma ESG han pasado las certificaciones EU EC1935-2004.

CÓMO PEDIR SU REFERENCIA:

Indicar Serie, Accionamiento, -, Extremos, -, DN, -, Diafragma, -, Función, -, Pulido.

Serie	Accionamiento	-	Extremos	-	DN	-	Diafragma	-	Función	-	Pulido
VD	P: Proporcional		T1: TRI-CLAMP ASME-BPE T2: TRI-CLAMP SMS3008 T3: TRI-CLAMP JIS-G3447 T4: TRI-CLAMP ISO1127 T5: TRI-CLAMP DIN11850 T6: TRI-CLAMP ASME-BPE-EN558-1		08: 8mm 10: 10mm 15: 15mm 20: 20mm 25: 25mm 40: 40mm 50: 50mm		M08: Diafragma 8 M10: Diafragma 10 M25: Diafragma 25 M40: Diafragma 40 M50: Diafragma 50		A: Simple Efecto N.C.		M: Estándar Pulido Estándar Ra ≤ 0,4μm E: Electro pulido
			S1: SOLDADO ASME-BPE S2: SOLDADO SMS3008 S3: SOLDADO JIS-G3447 S4: SOLDADO ISO1127 / DIN11866 B S5: SOLDADO DIN11850-0 S6: SOLDADO DIN11850-1 S7: SOLDADO DIN11850-2/DIN11866 A S8: SOLDADO DIN11850-3								

REGULADORES DE CAUDAL INOX



INOX



VXRE

Regulador caudal INOX-316 unidireccional.
Presión trabajo: 16 bar.
Junta VITÓN / Temperatura: 120°C.
Rosca BSP. Posibilidad bajo pedido de roscas NPT y SAE.

Ref.	Código	Rosca
VXRE 0101	0707507510110	1/8"
VXRE 0202	0707507510111	1/4"
VXRE 0303	0707507510112	3/8"
VXRE 0404	0707507510113	1/2"



INOX



VXREB

Ref.	Código	Rosca
VXREB 0101	0707507510114	1/8"
VXREB 0202	0707507510115	1/4"
VXREB 0303	0707507510116	3/8"
VXREB 0404	0707507510117	1/2"

Regulador caudal INOX-316 bidireccional.
Presión trabajo: 40 bar.
Junta VITÓN / Temperatura: 120°C. Rosca BSP. Posibilidad bajo pedido de roscas NPT y SAE.

REGULADORES DE CAUDAL INOX TIPO BANJO

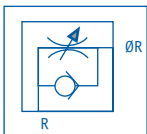

INOX

Ref.	Código	Rosca
VXREL-0101	0707507510118	H-1/8"
VXREL-0202	0707507510119	H-1/4"
VXREL-0303	0707507510120	H-3/8"
VXREL-0404	0707507510121	H-1/2"



VXREL

Regulador caudal INOX-316 unidireccional. Conexión Rosca Hembra. Junta FKM.
Presión trabajo: 10 bar. Temperatura máx.: 120°C.
Rosca BSP. Posibilidad bajo pedido de roscas NPT y SAE.

REGULADOR DE CAUDAL INOX TIPO BANJO - CONEXIÓN INSTANTÁNEA "VXEL"



INOX

Ref.	Código	Ø Ext. "T"	P	B	C	D	A/F1	A/F2
VXEL 04-M5	A CONSULTAR	4 mm	M5	4.0	24.0	14.0	11.0	9.5
VXEL 06-G01	0707507510097	6 mm	G1/8"	6.0	38.0	24.0	14.3	14.3
VXEL 06-G02	0707507510098	6 mm	G1/4"	8.0	43.0	27.0	19.0	17.4
VXEL 08-G01	0707507510099	8 mm	G1/8"	6.0	38.0	24.0	14.3	14.3
VXEL 08-G02	0707507510100	8 mm	G1/4"	8.0	43.0	27.0	19.0	17.4
VXEL 10-G02	0707507510101	10 mm	G1/4"	8.0	43.0	27.0	19.0	17.4
VXEL 10-G03	0707507510102	10 mm	G3/8"	8.0	51.0	31.0	22.0	20.6
VXEL 12-G03	0707507510103	12 mm	G3/8"	8.0	51.0	31.0	22.0	20.6
VXEL 12-G04	0707507510104	12 mm	G1/2"	10.0	57.0	33.0	27.0	24.0

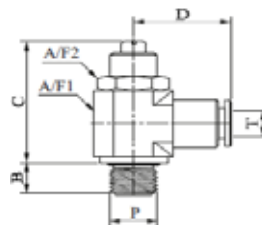

VXEL-G

"T" Tubo a Rosca macho BSPP (cilíndrica orientable). Junta FKM.
Presión trabajo: 10 bar. Temperatura máx.: 120°C.

REGULACIÓN

De rosca macho a rosca hembra añadir "ON" después de referencia.
De rosca hembra a rosca macho añadir "IN" después de referencia.

REGULADOR DE PRESIÓN MEDIA INOX 316 (Aire/Gas Técnico/Líquido)

NEW!

CARACTERÍSTICAS:

- . Máxima presión de entrada: hasta 50 bar.
- . Conexiones: roscas hembra BSPP (opcional bajo pedido NPTF).
- . Temperatura de trabajo: -20°+80°C.
- . Caudal máximo: ~ 400 Nm³/h.
- . Coeficiente de caudal kv (m³/h): 2,99 (UNI EN 60534-2).
- . Peso: 3,2 kg.
- . Clase de sellado de obturador: grado A (UNI EN 12266-1).
- . Conexión del manómetro: 1/4" BSPP.

MATERIALES:

- . Cuerpo y partes internas: acero inoxidable AISI 316L.
- . Juntas y obturador: FPM.
- . Juntas disponibles bajo pedido: EPDM, NBR, FVMQ.
- . Membrana: NBR+PTFE (PTFE en contacto con fluido).
- . Muelle de regulación: acero inoxidable.

CERTIFICACIONES:

- . PED 2014/68/UE.
- . ATEX dir. 2014/34/EU.
- . MOCA 1935/2004.

MEDIDAS:

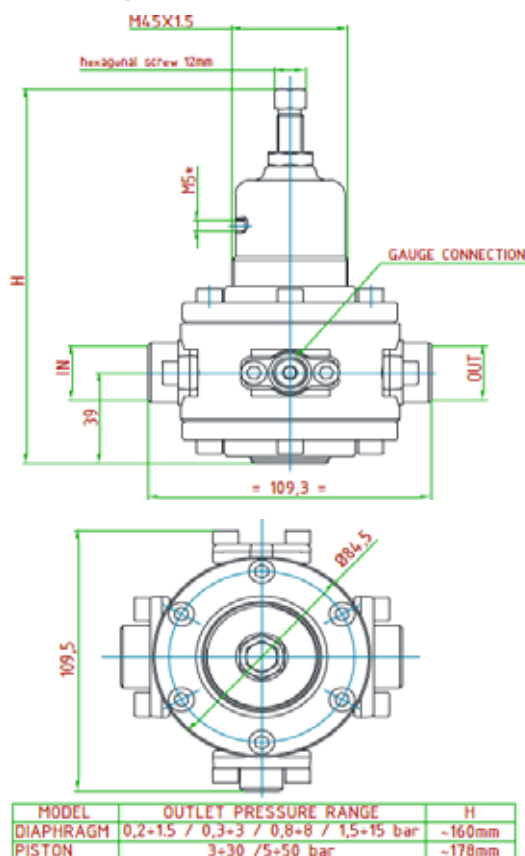

CONSÚLTENOS PARA OTROS MODELOS DE FILTROS-REGULADORES Y LUBRICADORES.



312R2

CARACTERÍSTICAS ESTÁNDAR DISPONIBLES (A especificar en sus pedidos)

Ref.	Conexiones	Rango de presión de salida
312R2	3/8" BSPP 1/2" BSPP	0,2 a 1,5 bar
		0,3 a 3 bar
		0,8 a 8 bar
		1,5 a 15 bar
		3 a 30 bar
		Modelo de pistón
		5 a 50 bar

OPCIONALES: Función Relieving / Manómetro / Kit soporte + tuerca.

DIAGRAMAS DE FLUJO PARA UNA PRESIÓN DE ENTRADA DE 10 BAR (AIRE):

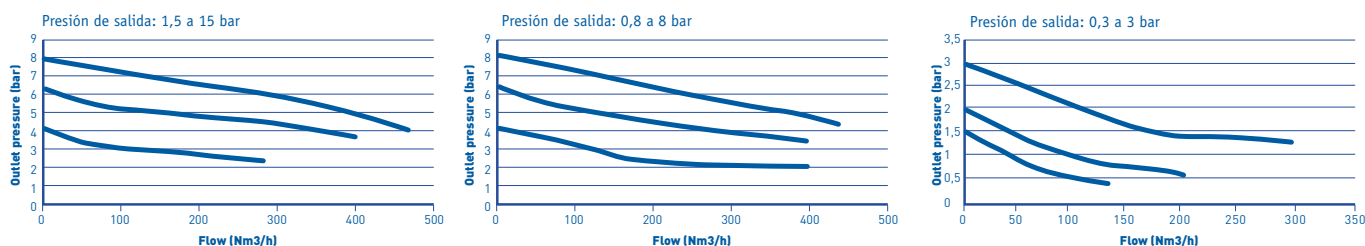

GAMA COMPLETA DE FILTRACIÓN



JUNTO A NUESTRA REPRESENTADA EATON, PODEMOS OFRECER SISTEMAS DE FILTRACIÓN Y SOLUCIONES A MEDIDA PARA LOS PROCESOS INDUSTRIALES MÁS RIGUROSOS, MEDIANTE FILTROS DE BOLSA, FILTROS DE CARTUCHO, FILTROS PRENSA, MÓDULOS LENTICULARES, FILTROS AUTO-LIMPIANTES, FILTROS HIDRÁULICOS, SEPARADORES GAS/LÍQUIDO Y SUS CORRESPONDIENTES CONSUMIBLES Y RECAMBIOS.

CONTACTE CON NUESTRO DPTO. TÉCNICO PARA ASESORARLE SOBRE NUESTRA EXTENSA GAMA DE FILTRACIÓN INDUSTRIAL.

**Solicite nuestro Programa Global,
el más completo del mercado en
Conducción Técnica de Fluidos,
de + 24.000 referencias.**

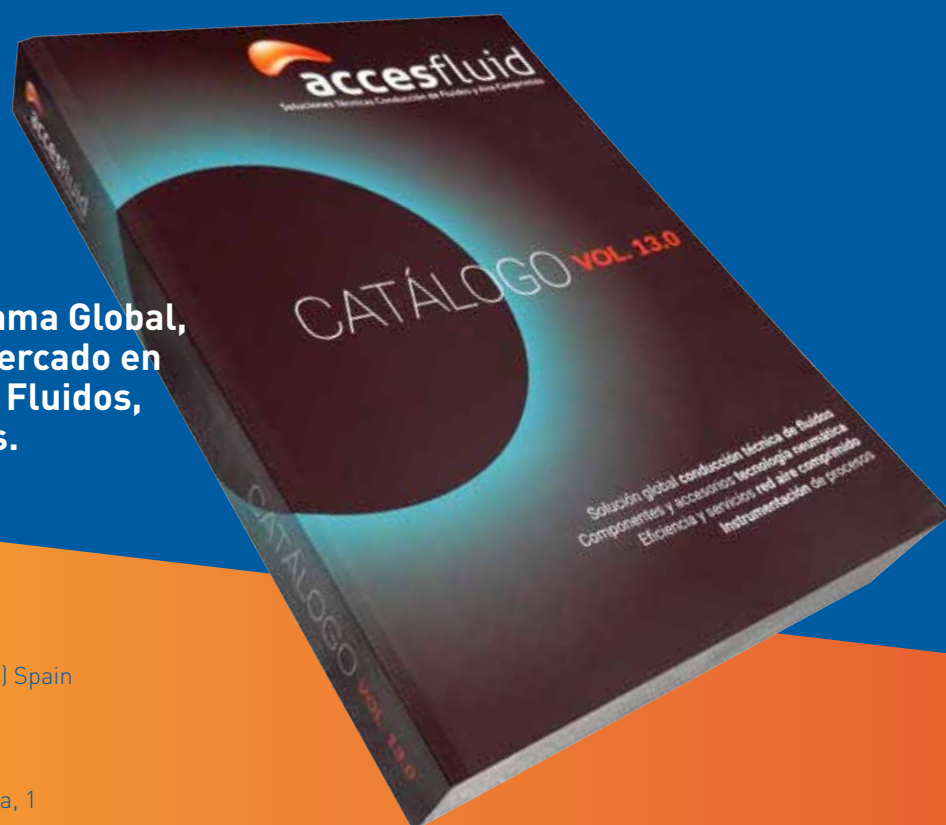

Pol. Ind. l'Ametlla Park · c/ Seva, 2
08480 L'AMETLLA DEL VALLÈS (BCN) Spain
T. +34 937 811 612
comercial@accesfluid.com
www.accesfluid.com

Pol. Ventorro del Cano · c/ Pedrezuela, 1
Ed. Delfos nº 209
28925 ALCORCÓN (Madrid) Spain

