



INSTALAIR

Redes modulares
Instalaciones de aire y fluidos

ÍNDICE **INSTALAIR**

UNA VARIEDAD DE VENTAJAS	693
ESPECIFICACIONES GENERALES	693
TABLA DE SECCIONES DE DIÁMETRO	694
GUÍA DE INSTALACIÓN	695
TUBERÍA DE ALUMINIO PARA REDES MODULARES	696
RACORES RÁPIDOS	696-701
ADAPTADOR A ROSCA	701
BRIDAS A TUBO	701
SOPORTE PARA BRIDAS Y VÁLVULAS	702
TORNILLOS Y JUNTAS BRIDAS	702
COMPENSADORES DILATACIÓN	702
MANGUERAS FLEXIBLES COMPENSADORAS	703
VÁLVULA CORTE PILOTADA INOX 304	703
VÁLVULAS MODULARES VÁLVULA BOLA LATÓN, PASO TOTAL PN 40	704
RECAMBIOS PARA RACORES RÁPIDOS	704
RACORES ACCESORIO INOX AISI 316	705-707
RACORES 3 PIEZAS EN LATÓN NIQUELADO	708
DISTRIBUIDORES APLIQUE MURAL	708
DISTRIBUIDORES APLIQUE MURAL MÚLTIPLE	709
HERRAMIENTAS DE MONTAJE	710
COMPLEMENTOS SOPORTACIÓN	711-712
UNIDAD DE TRATAMIENTO DE AIRE COMPRIMIDO SELECCIÓN RÁPIDA	713-714
ACCESORIOS GRUPOS DE FILTRAJE	714



**EN FORMATO PDF,
PONEMOS A SU DISPOSICIÓN
TODA LA INFORMACIÓN TÉCNICA
Y DATOS ESPECÍFICOS
DE NUESTRAS REFERENCIAS.**

Pídalo a través de comercial@accesfluid.com

UNA VARIEDAD DE VENTAJAS: RÁPIDO, FÁCIL Y FIABLE.

TOTALMENTE PERSONALIZABLE

La gama de accesorios AIRnet puede instalarse en paredes o techos y le permite crear un sistema de aire comprimido personalizado que se ajuste específicamente a sus necesidades de producción.

SIN FUGAS

Los accesorios AIRnet son resistentes a la corrosión. Garantizan una instalación exenta de fugas y eliminan el derroche de energía.

MÁXIMA FLEXIBILIDAD

Se pueden añadir tomas rápidas en cualquier momento para crear tramos de descarga adicionales. Como la conexión se realiza desde la sección lateral, se elimina el riesgo de contaminación por condensados.

CALIDAD CONSTANTE DEL AIRE

AIRnet suministra aire de calidad constante desde el punto de producción hasta los diversos puntos de uso, protegiendo el equipo aguas abajo y los procesos de fabricación.

PENSANDO EN EL FUTURO

Como todos los componentes se adaptan fácilmente y son reutilizables, AIRnet facilita las ampliaciones futuras de la red.

FÁCIL IDENTIFICACIÓN

En cumplimiento con la mayoría de las normas industriales, las tuberías AIRnet están pintadas en azul o verde, de forma estándar, para facilitar la identificación de la red.

BAJA CAÍDA DE PRESIÓN

El diseño de paso total y las guías de aletas internas eliminan las restricciones del flujo de aire y garantizan la caída de presión más baja posible.

ESPECIFICACIONES GENERALES

CRITERIOS DE RENDIMIENTO

- Compatible con aire comprimido, vacío y gases inertes.
- Presión máxima de trabajo PN16 bar para temperaturas de entre -20°C (-4°F) y +80°C (158°F).
- Nivel de vacío 13 mbar(a) (0,189 psia) presión absoluta.
- Punto de rocío a presión más bajo admisible: -70°C (-94°F).
- Resistente a los efectos de los aceites de compresores (aceites minerales / a base de PAO / a base de éster).
- La gama es resistente al fuego (de acuerdo con UL94 HB).
- Los tubos son resistentes a la radiación ultravioleta directa y los accesorios son resistentes a la radiación ultravioleta indirecta.
- Sin corrosión.
- Sin fugas.
- Sin silicona.



CONFORMIDAD

EN 13480 / Directiva 2014/68/EU "PED", ASME B31.1 y EN 755-2
Cumple las normas comunes sobre equipos de presión PED - CE - ASME - MOL - UDT - SQL - CRN - DIR - MOM.

DISEÑO

Nuevo diseño.



CONECTORES TUBO POLÍMERO	CONECTORES ALUMINIO	CONECTORES ACERO - ALUMINIO	TUBOS ALUMINIO
Ø20 - 25 - 40 - 50 mm	Ø63 - 80 mm	Ø100 - 158 mm	20 - 25 - 40 - 50 - 63 - 80 - 100 - 158
3/4" - 1" - 1 1/2" - 2"	2 1/2" - 3"	4" - 6"	3/4" - 1" - 1 1/2" - 2" - 2 1/2" - 3" - 4" - 6"

CARACTERÍSTICAS:

- Material PA6 con 30% inyección de fibra de vidrio.
- Anillo retenedor: Acero Inoxidable.
- Junta: Caucho NBR 70SH.
- Estampado: Designación de roscas. Diámetro nominal DN. Fecha de fabricación marcada (año/mes).

CARACTERÍSTICAS:

- Aleación de aluminio EN AW-6082.
- Anillo retenedor: Acero Inoxidable.
- Junta: Caucho NBR 70SH.
- Estampado: Designación de roscas. Diámetro nominal DN. Fecha de fabricación marcada (año/mes).

CARACTERÍSTICAS:

- Material abrazadera: Chapa de acero S355MC, según EN10149-2.
- Conector: Aluminio AISI 9Mg
- Anillo retenedor: Acero Inoxidable AISI 304.
- Junta: Caucho NBR 70SH.
- Estampado: Designación de roscas. Diámetro nominal DN. Fecha de fabricación marcada (año/mes).

CARACTERÍSTICAS:

- Aluminio extruido ANSI B241 aleación EN AW-6060 T6.
- Indicación de máxima presión de diseño.
- Estampado: Designación de roscas. Diámetro nominal DN. Fecha de fabricación marcada (año/mes).
- Certificado QUALICOAT.

DESIGNACIÓN DE ROSCAS

01	02	03	04	05	06	07	08	09	10	11	12	13
R-1/8"	R-1/4"	R-3/8"	R-1/2"	R-3/4"	R-1"	R-1 1/4"	R-1 1/2"	R-2"	R-2 1/2"	R-3"	R-4"	R-6"

TABLA DE SECCIONES DE DIÁMETRO

Basada en la longitud de la red, excluyendo la longitud equivalente de los accesorios.

Presión de trabajo 7 bar (101,5 psi). Caída de presión 0,4 bar (5,8 psi).

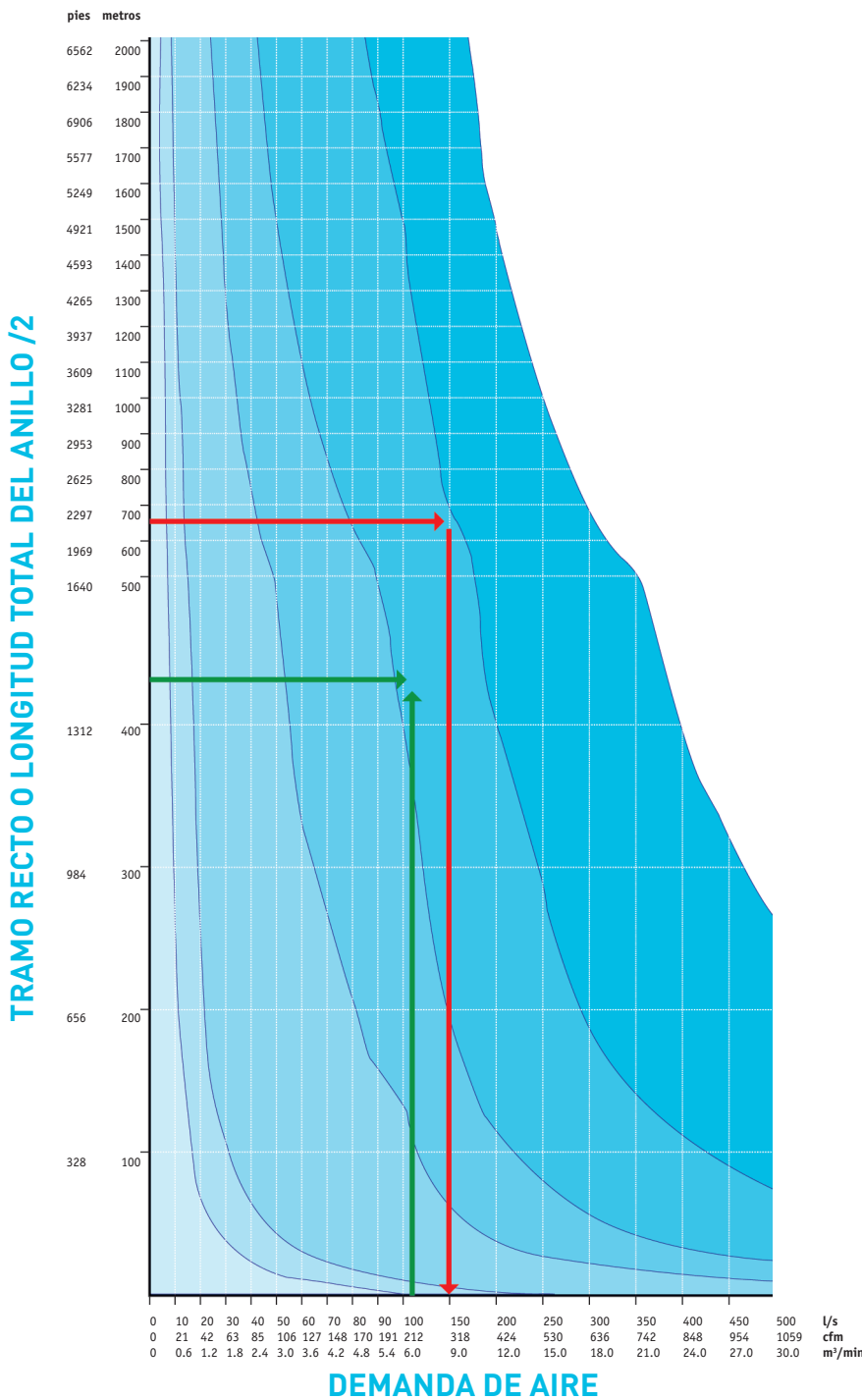

Problema:

La demanda total de aire es de 105 l/s (a 7 bar / 101,5 psi) con una longitud total del anillo de 420 m (1378 pies).

Solución:

La tabla de arriba recomienda la utilización de tuberías con un diámetro de 63 mm (2½"). El cruce se sitúa en la zona de comienzo de la sección de Ø 63 mm (2½"), lo cual significa que la caída de presión será probablemente menor de 0,2 bar (2,9 psi). Si se seleccionase un diámetro de 50 mm (2") se produciría una caída de presión superior a 0,5 bar (7,3 psi).

Problema:

Un cliente quiere saber la demanda de aire máxima permitida en una línea de distribución existente de 670 m (2198 pies) diseñada con un diámetro de 63 mm (2½").

Solución:

La tabla de arriba recomienda un consumo de aire máximo de 150 l/s para una caída de presión de 0,4 bar (5,8 psi).

Ø100 mm-158 mm

Para estos diámetros, consultar a nuestro departamento técnico.

Ø80 mm / 3"

Ø63 mm / 2½"

Ø50 mm / 2"

Ø40 mm / 1½"

Ø25 mm / 1"

Ø20 mm / ¾"

CÁLCULO DE DILATACIÓN - CONTRACCIÓN

Para evitar los efectos de la dilatación/contracción, se deben considerar las siguientes precauciones:

1. Sostener y embridar la instalación de manera que la tubería pueda correr libremente entre dos puntos fijos.

2. Cuando la distancia en línea recta supere los 50 metros, será necesario introducir un compensador.

En instalaciones exteriores y/o en aquellas en las que las condiciones térmicas sean críticas (extremas) se debe reducir esta distancia.

Consultar a nuestro departamento técnico.

Cálculo de dilatación: $\Delta l = dxLx\Delta T$

ΔL: variación de longitud de la tubería (dilatación o contracción).

d: coeficiente de dilatación lineal del aluminio = 0.024 mm/m/°C.

L: longitud de la tubería.

ΔT: variación de temperatura (°C).



AIRNET PLANER
¡Solicite su proyecto 3D!

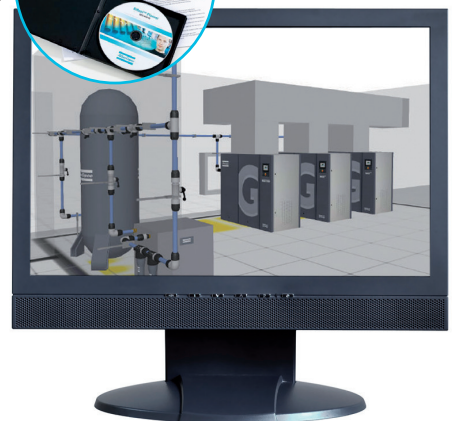

GUÍA DE INSTALACIÓN PF SERIES Ø 20-50 mm



Cortar el tubo



Desbarbar



Marcar y lubricar



Empujar el tubo en el accesorio

GUÍA DE INSTALACIÓN Ø 63-80 mm



Cortar el tubo



Desbarbar



Marcar



Empujar el tubo en el accesorio



Apretar la conexión



Montaje rápido de bajantes



GUÍA DE INSTALACIÓN Ø 100-158 mm

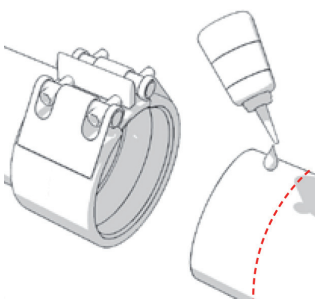

Lubricar

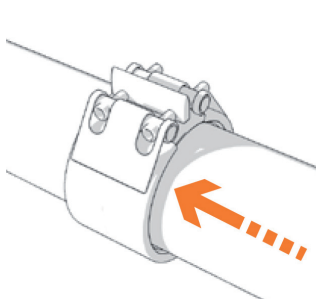

Insertar

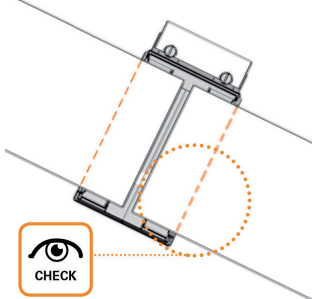

Verificar

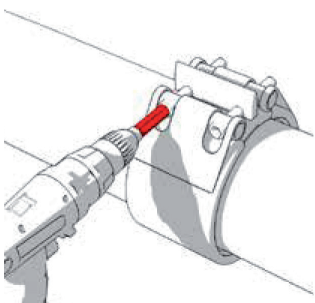

Apriete

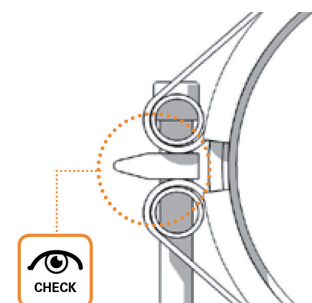
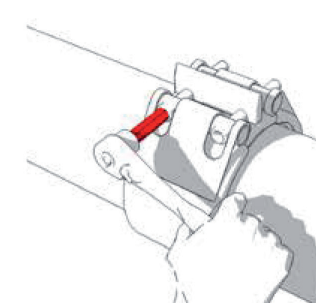

Verificar

TUBERÍA DE ALUMINIO PARA REDES MODULARES

CARACTERÍSTICAS:

- . Paso total del aire. Coeficiente mínimo de rozamiento.
- . Calidad, resistencia y durabilidad.
- . No exige mantenimiento.
- . Su anticorrosión elimina riesgos de fuga.

. Tubería de aluminio extruido ANSI B241 aleación UNS A96063 T5. Tratamiento de cromofosfatación interno y externo. Acabado con electropintura externa.

Ref.	Código	Ø ext.	Ø int.	Long.	Peso	Color		
		mm	mm			Aire Comp.	Gases inertes	Vacío
Tubo 17x20	0404204210004	20	17	2,85	0,58	Azul	-	-
Tubo 22x25	0404204210006	25	22	2,85	0,76	Azul	-	-
Tubo 36x40	0404204210008	40	36	2,85	1,64	Azul	-	-
Tubo 46x50	0404204210010	50	46	2,85	2,29	Azul	-	-
Tubo 59x63	0404204210012	63	59	2,85	3,04	Azul	-	-
Tubo 76x80	0404204210014	80	76	2,85	4,79	Azul	-	-
Tubo 17x20	0404204210005	20	17	5,7	1,16	Azul	Verde	Gris
Tubo 22x25	0404204210007	25	22	5,7	1,52	Azul	Verde	Gris
Tubo 36x40	0404204210009	40	36	5,7	3,27	Azul	Verde	Gris
Tubo 46x50	0404204210011	50	46	5,7	4,57	Azul	Verde	Gris
Tubo 59x63	0404204210013	63	59	5,7	6,08	Azul	Verde	Gris
Tubo 76x80	0404204210015	80	76	5,7	9,57	Azul	Verde	Gris
Tubo 94x100	0404204210016	100	94	5,7	13,79	Azul	Verde	Gris
Tubo 150,5x158	A CONSULTAR	158	150,5	5,7	27,36	Azul	Verde	Gris

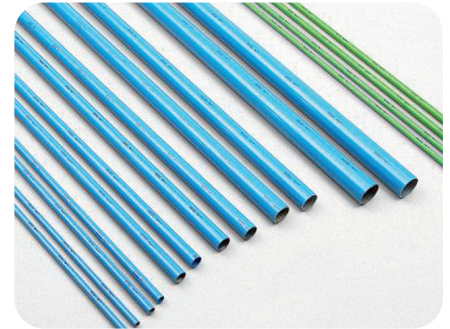

DOBLE CURVA 45°

Ref.	Código	H (mm)	L (mm)
JNSC 2000	0404204240004	440	150
JNSC 2500	0404204240005	460	150

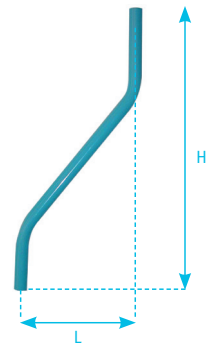

RACORES RÁPIDOS

CARACTERÍSTICAS:

- . Gran facilidad de conexión: Sistema de pinza y tuerca de apriete.
- . Pinza multiagarre Inox AISI 316: Óptima sujeción del tubo.
- . Diseño del cuerpo en poliamida. Ligeros y compactos.

FIG. A

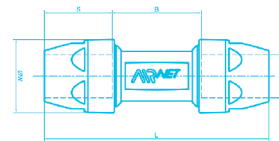

FIG. B

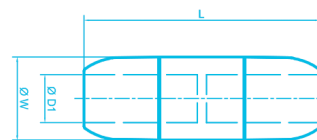
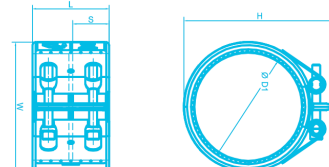

FIG. C



CONEXIÓN TUBO / TUBO

Ref.	Código	Ø ext.	L (mm)	W (mm)	Material	Fig.
JNUC 20	0404204260111	20	127,6	37,5	Tecnopolímero	A
JNUC 25	0404204260112	25	138,1	43,5	Tecnopolímero	A
JNUC 40	0404204260113	40	208,8	67,8	Tecnopolímero	A
JNUC 50	0404204260114	50	239	83,9	Tecnopolímero	A
JNUC 63	0404204260115	63	160	89	Aluminio	B
JNUC 80	0404204260116	80	198	113	Aluminio	B
JNUC 100	0404204260109	100	98	132	Acero-Aluminio	C
JNUC 158	0404204260110	158	115	192,8	Acero-Aluminio	C

JNUC
Conexión tubo / tubo.

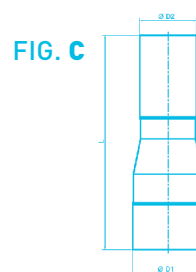
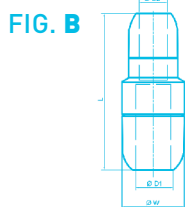
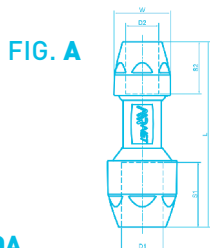

UNIÓN TUBO REDUCIDA

Ref.	Código	D1	D2	L (mm)	W (mm)	Material	Fig.
JNG 2520	0404204260039	25	20	133	43,5	Tecnopolímero	A
JNG 4025	0404204260040	40	25	173	67,8	Tecnopolímero	A
JNG 5040	0404204260041	50	40	224	74	Tecnopolímero	A
JNG 6350	0404204260042	63	50	185	89	Tecnopolímero	A
JNG 8063	0404204260043	80	63	191	113	Aluminio	B
JNG 10080	0404204260037	100	80	304	-	Acero-Aluminio	C
JNG 158100	0404204260038	158	100	269	-	Acero-Aluminio	C
JNG 6340	A CONSULTAR	63	40	-	-	Acero-Aluminio	D
JNG 8040	A CONSULTAR	80	40	-	-	Acero-Aluminio	D
JNG 8050	A CONSULTAR	80	50	-	-	Acero-Aluminio	D

CONEXIÓN A TUBO

1xJNUC 100 - 1xJNUC 80
1xJNUC 100 - 1xJNUC 158



JNG
Unión tubo reducida.

FIG. A

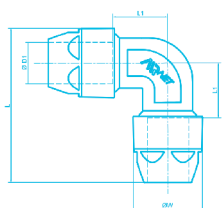

FIG. B

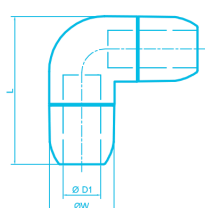
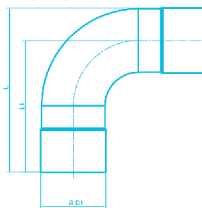

FIG. C



CODO TUBO - TUBO 90°

Ref.	Código	D	L (mm)	W (mm)	Material	Fig.
JNUL 20	0404204260119	20	83	37,5	Tecnopolímero	A
JNUL 25	0404204260120	25	96	43,5	Tecnopolímero	A
JNUL 40	0404204260121	40	148	67,8	Tecnopolímero	A
JNUL 50	0404204260122	50	186	83,9	Tecnopolímero	A
JNUL 63	0404204260123	63	157	89	Aluminio	B
JNUL 80	0404204260124	80	197	113	Aluminio	B
JNUL 100	0404204260117	100	252	-	Acero-Aluminio	C
JNUL 158	0404204260118	158	248	-	Acero-Aluminio	C

CONEXIÓN A TUBO

2xJNUC 100
2xJNUC 158

JNUL
Codo tubo - tubo 90°.

FIG. A

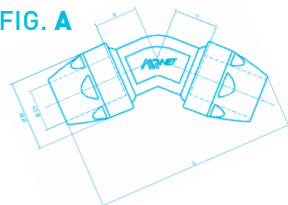

FIG. B

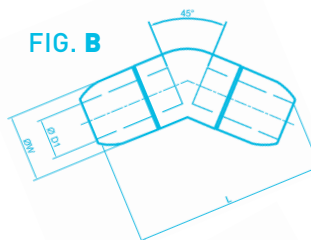
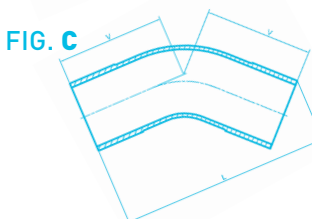

FIG. C



CODO TUBO - TUBO 45°

Ref.	Código	D	L (mm)	W (mm)	Material	Fig.
JNUY 20	0404204220023	20	109	37,5	Tecnopolímero	A
JNUY 25	0404204220024	25	128	43,5	Tecnopolímero	A
JNUY 40	0404204220025	40	195	67,8	Tecnopolímero	A
JNUY 50	0404204220026	50	241	83,9	Tecnopolímero	A
JNUY 63	0404204220027	63	202	89	Aluminio	B
JNUY 80	0404204220028	80	246	113	Aluminio	B
JNUY 100	0404204220021	100	287	-	Acero-Aluminio	C
JNUY 158	0404204220022	158	285	-	Acero-Aluminio	C

CONEXIÓN A TUBO

2xJNUC 100
2xJNUC 158

JNUY
Codo tubo - tubo 45°.

FIG. A

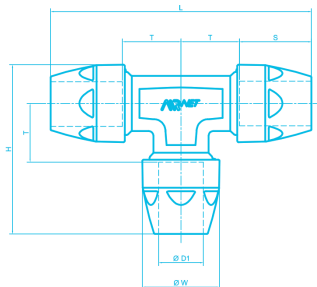

FIG. B

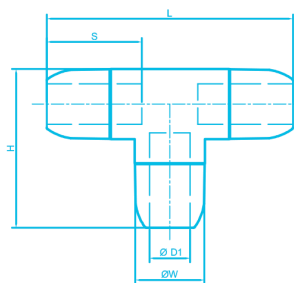
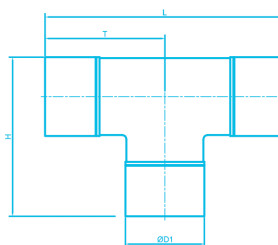

FIG. C



"T" TUBO / TUBO / TUBO

Ref.	Código	D	L (mm)	H (mm)	W (mm)	Material	Fig.
JNUT 20	0404204260127	20	128	82,6	37,5	Tecnopolímero	A
JNUT 25	0404204260128	25	148	95,7	43,5	Tecnopolímero	A
JNUT 40	0404204260129	40	229	148,3	67,8	Tecnopolímero	A
JNUT 50	0404204260130	50	289	186,1	83,9	Tecnopolímero	A
JNUT 63	0404204260131	63	226	157	89	Aluminio	B
JNUT 80	0404204260132	80	281	197	113	Aluminio	B
JNUT 100	0404204260125	100	304	202	-	Acero-Aluminio	C
JNUT 158	0404204260126	158	320	238,8	-	Acero-Aluminio	C

CONEXIÓN A TUBO

3xJNUC 100

3xJNUC 158

JNUT

"T" tubo / tubo / tubo.

FIG. A

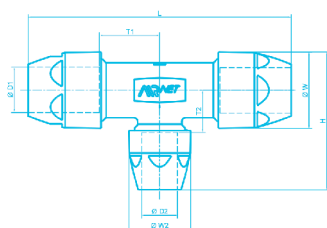

FIG. B

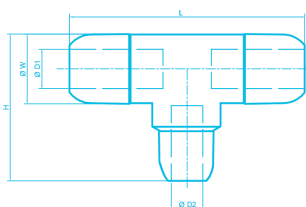
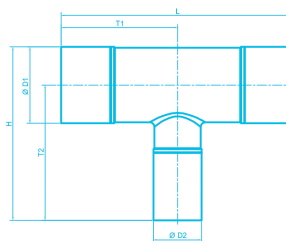

FIG. C



"T" TUBO REDUCIDA

Ref.	Código	D1	D2	L (mm)	H (mm)	Fig.
JNTR 2520	0404204260101	25	20	148	90,5	A
JNTR 4020	0404204260102	40	20	229	112,7	A
JNTR 4025	0404204260103	40	25	229	117,9	A
JNTR 5020	0404204260104	50	20	289	130,6	A
JNTR 5025	0404204260105	50	25	289	135,9	A
JNTR 5040	0404204260106	50	40	289	151,3	A
JNTR 6350	0404204260107	63	50	226	233	B
JNTR 8063	0404204260108	80	63	281	191	B
JNTR 10050	0404204260096	100	50	304	227	C
JNTR 10063	0404204260097	100	63	304	227	C
JNTR 10080	0404204260098	100	80	304	252	C
JNTR 15880	0404204260100	158	80	320	310,3	C
JNTR 158100	0404204260099	158	100	320	280,8	C

CONEXIÓN A TUBO

2xJNUC 100- 1xJNUC 50

2xJNUC 100 - 1xJNUC 63

2xJNUC 100 - 1xJNUC 80

2xJNUC 158 - 1xJNUC 80

2xJNUC 158 - 1xJNUC 100

JNTR

"T" tubo reducida.

FIG. A

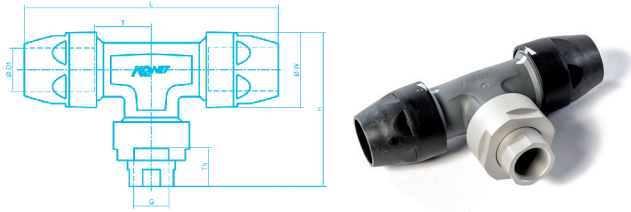
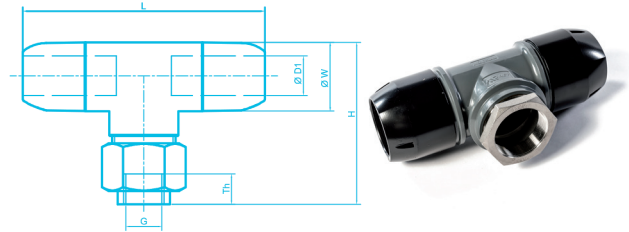

FIG. B



"T" TUBO / ROSCA CENTRAL H / TUBO

Ref.	Código	D	R	L (mm)	W (mm)	Material	Fig.
JNTFD 2003	0404204260087	20	3/8"	128	37,5	Tecnopolímero	A
JNTFD 2004	0404204260088	20	1/2"	128	37,5	Tecnopolímero	A
JNTFD 2504	0404204260089	25	1/2"	148	43,5	Tecnopolímero	A
JNTFD 2505	0404204260090	25	3/4"	148	43,5	Tecnopolímero	A
JNTFD 4006	0404204260091	40	1"	229	67,8	Tecnopolímero	A
JNTFD 5006	0404204260092	50	1"	289	83,9	Tecnopolímero	A
JNTFD 6309	0404204260093	63	2"	226	89	Aluminio	B
JNTFD 8010	0404204260094	80	2 1/2"	281	113	Aluminio	B
JNTFD 8011	0404204260095	80	3"	281	113	Aluminio	B
JNTFD 10006	0404204260085	100	1"	304	-	Acero-Aluminio	C
JNTFD 15806	0404204260086	158	1"	320	-	Acero-Aluminio	C

FIG. C

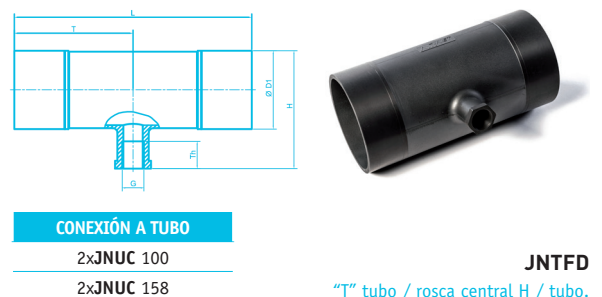
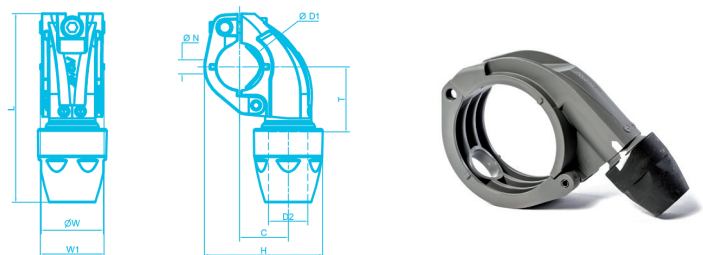

FIG. A



DERIVACIÓN RÁPIDA TUBO

Ref.	Código	D1	D2	L (mm)	W (mm)	Fig.
JNDL 2520	0404204260017	25	20	103	37,5	A
JNDL 4020	0404204260018	40	20	119	37,5	A
JNDL 4025	0404204260019	40	25	125	43,5	A
JNDL 5020	0404204260020	50	20	131	37,5	A
JNDL 5025	0404204260021	50	25	136	43,5	A
JNDL 6320	0404204260022	63	20	143	37,5	B
JNDL 6325	0404204260023	63	25	148	43,5	B
JNDL 8020	0404204260024	80	20	163	37,5	B
JNDL 8025	0404204260025	80	25	168	43,5	B

FIG. B

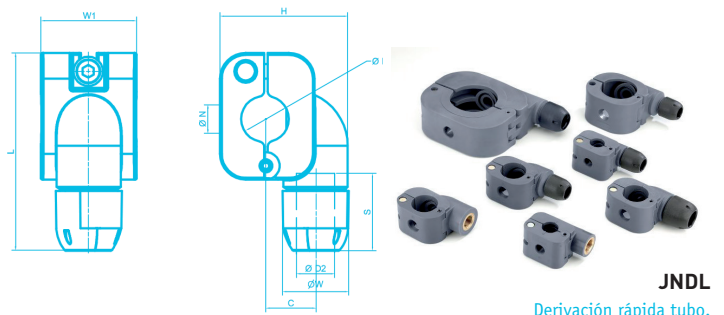
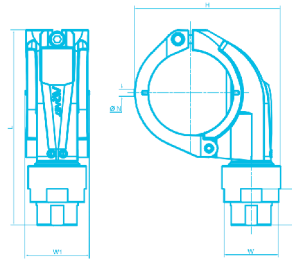

FIG. A



DERIVACIÓN RÁPIDA ROSCA HEMBRA

Ref.	Código	D	R	L (mm)	W (mm)	Fig.
JNDLF 2504	0404204260028	25	1/2"	107	36	A
JNDLF 4004	0404204260029	40	1/2"	124	36	A
JNDLF 4005	0404204260030	40	3/4"	124	41	A
JNDLF 5004	0404204260031	50	1/2"	135	36	A
JNDLF 5005	0404204260032	50	3/4"	135	41	A
JNDLF 6304	0404204260033	63	1/2"	148	36	A
JNDLF 6305	0404204260034	63	3/4"	148	41	A
JNDLF 8004	0404204260035	80	1/2"	167	36	A
JNDLF 8005	0404204260036	80	3/4"	167	41	A
JNDLF 10006	0404204260026	100	1"	156	63	B
JNDLF 15806	0404204260027	158	1"	192	63	B

FIG. B

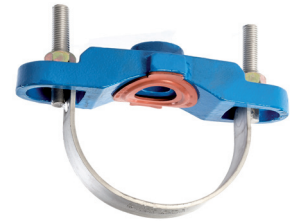
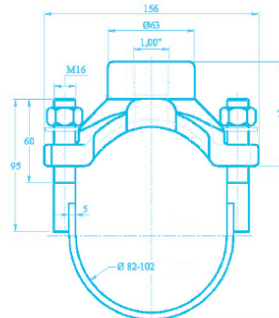

JNDLF

Derivación rápida rosca hembra.
Latón cromado.

FIG. A

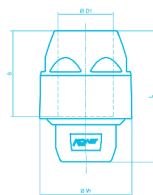

FIG. B

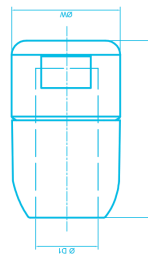
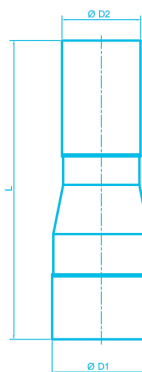

FIG. C



TAPÓN FINAL DE LÍNEA

Ref.	Código	D	L (mm)	W (mm)	Material	Fig.
JNPF 2000	0404204260071	20	58,8	37,5	Tecnopolímero	A
JNPF 2500	0404204260072	25	69	43,5	Tecnopolímero	A
JNPF 4000	0404204260073	40	99,4	67,8	Tecnopolímero	A
JNPF 5000	0404204260074	50	119,5	83,9	Tecnopolímero	A
JNPF 6300	0404204260075	63	104	90	Aluminio	B
JNPF 8000	0404204260076	80	109	113	Aluminio	B
JNPF 100	0404204260070	100	270	158	Acero-Aluminio	C
JNPF 158	A CONSULTAR	158	270	158	Acero-Aluminio	C

CONEXIÓN A TUBO

1xJNUC 100

1xJNUC 158

JNPF

Tapón final de línea.

RACORES RÁPIDOS



RECTO MACHO ALUMINIO ROSCA CÓNICA

Ref.	Código	D	R	L (mm)	W (mm)	Fig.
JNM 2004	0404204260048	20	1/2"	73,8	37,5	A
JNM 2005	0404204260049	20	3/4"	73,8	37,5	A
JNM 2505	0404204260050	25	3/4"	86	43,5	A
JNM 2506	0404204260051	25	1"	86	43,5	A
JNM 4007	0404204260052	40	1 1/4"	127,4	67,8	A
JNM 4008	0404204260053	40	1 1/2"	127,4	67,8	B
JNM 5008	0404204260054	50	1 1/2"	141	83,9	B
JNM 5009	0404204260055	50	2"	141	83,9	B
JNM 6309	0404204260056	63	2"	123	89	B
JNM 6310	0404204260057	63	2 1/2"	127	89	B
JNM 8010	0404204260058	80	2 1/2"	131	113	B
JNM 8011	0404204260059	80	3"	134	113	B



FIG. A

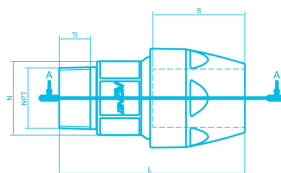
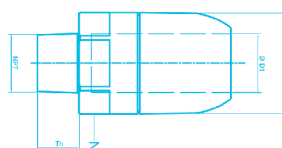

FIG. B



JNM

Recto macho aluminio rosca cónica.

RECTO HEMBRA ALUMINIO

Ref.	Código	D	R	L (mm)	W (mm)	Material	Fig.
JNMF 2005	0404204260060	20	3/4"	131,8	44	Tecnopolímero	A
JNMF 2506	0404204260061	25	1"	164,1	68,5	Tecnopolímero	A
JNMF 4008	0404204260062	40	1 1/2"	219,4	67,8	Tecnopolímero	A
JNMF 5009	0404204260063	50	2"	234,6	83,9	Tecnopolímero	A
JNMF 6310	0404204260064	63	2 1/2"	182	89	Aluminio	B
JNMF 8011	0404204260065	80	3"	196	113	Aluminio	B

FIG. A

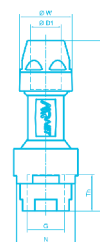

3 piezas tuerca loca.

FIG. B

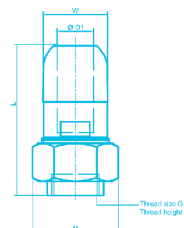

JNMF

Recto hembra aluminio.

ADAPTADOR A ROSCA



Ref.	Código	Ø tubo	R
JNAD 2003	0404204260006	20	3/8"
JNAD 2004	0404204260007	20	1/2"
JNAD 2504	0404204260008	25	1/2"
JNAD 2505	0404204260009	25	3/4"
JNAD 4006	0404204260010	40	1"
JNAD 5008	0404204260011	50	1 1/2"
JNAD 5009	0404204260012	50	2"



JNAD

Adaptador a rosca tuerca loca.

BRIDAS A TUBO



Ref.	Código	Ø Tubo	Ø Brida	Peso	Fig.
		mm	mm	kg	
JNBRI 63	0404204260015	63	185	0,9	A
JNBRI 80	0404204260016	80	200	1,4	A
JNBRI 100	0404204260013	100	220	2,6	B
JNBRI 158	0404204260014	158	285	5,3	B

FIG. A

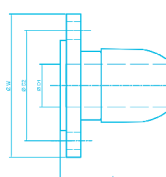
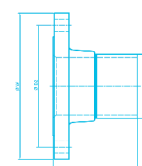

FIG. B



JNBRI

Bridas según norma DIN.

SOPORTE PARA BRIDAS Y VÁLVULAS

Ref.	Código
JNSOP 63	0404204260083
JNSOP 80	0404204260084
JNSOP 100	0404204260081
JNSOP 158	0404204260082



JNSOP

TORNILLOS Y JUNTAS BRIDAS

Ref.	Código	Ø tubo	Ø brida
JTKITM12	0404204260141	100 mm	220 mm
JTKITM16	0404204260142	158 mm	285 mm



JTKITM
Kit 8 unidades.

Ref.	Código	Ø tubo
JJUB 63	0404204260004	63
JJUB 80	0404204260005	80
JJUB 100	0404204260002	100
JJUB 158	0404204260003	158



JJUB

Junta plana para bridas.

COMPENSADORES DILATACIÓN

Ref.	Código	R1	R2	L	Compresión	Expansión
		macho	hembra			
JCM 0404	0404204220001	1/2"	1/2"	140	25	25
JCM 0505	0404204220002	3/4"	3/4"	140	25	25
JCM 0606	0404204220003	1"	1"	140	25	25
JCM 0707	0404204220004	1 1/4"	1 1/4"	140	25	25
JCM 0808	0404204220005	1 1/2"	1 1/2"	140	25	25
JCM 0909	0404204220006	2"	2"	140	25	25
JCM 1010	A CONSULTAR	2 1/2"	2 1/2"	140	25	25
JCM 1111	A CONSULTAR	3"	3"	140	25	25

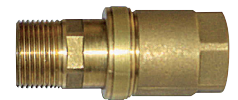

JCM

Compensador lineal.

Ref.	Código	R1	L	Compresión	Expansión	Peso
		hembra				
JCMF 0505	0404204220014	3/4"	200	22	6	0,7
JCMF 0606	0404204220015	1"	200	22	6	1,0
JCMF 0707	0404204220016	1 1/4"	200	22	6	1,2
JCMF 0808	0404204220017	1 1/2"	200	22	6	1,7
JCMF 0909	0404204220018	2"	200	22	6	2,6
JCMF 1010	0404204220019	2 1/2"	200	22	6	3,4
JCMF 1111	0404204220020	3"	200	22	6	5,2



JCMF

Compensador roscado con junta EPDM

Ref.	Código	Conexión	Ø Paso	L Reposo	Compresión	Expansión	Peso
			mm				
JCMB 0707	0404204220007	1 1/4"	68	175	50	30	3,1
JCMB 0808	0404204220008	1 1/2"	68	175	50	30	3,6
JCMB 0909	0404204220009	2"	86	175	50	30	4,5
JCMB 1010	0404204220010	2 1/2"	106	175	50	30	5,2
JCMB 1111	0404204220011	3"	118	175	50	30	6,7
JCMB 1212	0404204220012	4"	152	225	57	37	7,2
JCMB 1313	0404204220013	6"	194	225	57	37	10



JCMB

Compensador brida con junta EPDM

MANGUERAS FLEXIBLES COMPENSADORAS

AR NET

Se trata de mangueras de alta calidad que cumplen las normas industriales PN16. Se pueden usar para muchos propósitos: absorber la dilatación y contracción térmica, eludir obstáculos y absorber la vibración o ampliar el circuito.



JNFLEX

Compensador flexible.

Ref.	Código	Long. m	R	Conexión
JNFLEX 0507R	0404204270048	0,7	3/4"	recta
JNFLEX 0515R	0404204270049	1,5	3/4"	recta
JNFLEX 0607R	0404204270050	0,7	1"	recta
JNFLEX 0615R	0404204270051	1,5	1"	recta
JNFLEX 0710L	0404204270052	1	1 1/2"	codo 90ª
JNFLEX 0715R	0404204270053	1,5	1 1/2"	recta
JNFLEX 0910L	0404204270054	1	2"	codo 90ª
JNFLEX 0915R	0404204270055	1,5	2"	recta

OPCIONAL: Cable anti-latigazo.

INOX

VÁLVULA CORTE PILOTADA INOX 304



CARACTERÍSTICAS:

- . Cuerpo AISI 304 (CF8) y junta FKM.
- . Roscas BSP (opcional bajo pedido NPT).
- . Presión máx. fluido: 16 bar.
- . Presión de control: de 3 a 8 bar.
- . Fluido de control: aire/gas inerte.
- . Temperatura fluido: -20°C a +150°C.

- . Temperatura ambiente: -20°C a +150°C.
- . Compatible con la mayoría de fluidos excepto vapor.
- . Pilotaje neumático.
- . Puede ser utilizada en horizontal, vertical u oblicuo.

APLICACIONES:

- . Control de redes de aire comprimido.
- . Cierre remoto de conducciones aéreas.
- . Cuando se requiere rapidez de cierre de sistema.
- . Incluye diseño para pilotaje con válvula tipo NAMUR (consultar válvulas neumáticas).

CONSÚLTENOS EN INOX AISI 316

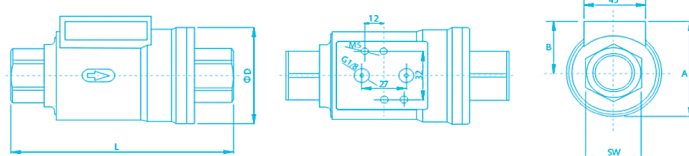

Rosca	DN	A (mm)	D (mm)	SW (mm)	B (mm)	L (mm)	kgs
3/8"	10	56	46	22	33	98	0,8
1/2"	15	61	52	26,5	35	112	1
3/4"	20	72	64	32	40	135	1,5
1"	25	78	69	41	43	143	1,92
1 1/4"	32	94	86	50	51	165	3,06
1 1/2"	40	104	96	56	56	180	3,76
2"	50	116	108	70	62	207	5,71



SF

Válvula corte pilotada Inox 304

NEW!

DOBLE EFECTO

Ref.	Código	Rosca
SF200320G	0707407410102	3/4"
SF200325G	0707407410103	1"
SF200340G	0707407410104	1 1/2"

NORMALMENTE ABIERTA

Ref.	Código	Rosca
SF200110G	0707407410092	3/8"
SF200115G	0707407410093	1/2"
SF200120G	0707407410094	3/4"
SF200125G	0707407410096	1"
SF200132G	0707407410098	1-1/4"
SF200140G	0707407410099	1-1/2"
SF200150G	0707407410101	2"

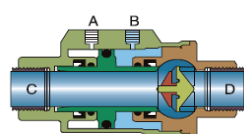

Esquema de funcionamiento

NEW!

NORMALMENTE CERRADA

Ref.	Código	Rosca
SF200120GNC	0707407410095	3/4"
SF200125GNC	0707407410097	1"
SF200140GNC	0707407410100	1 1/2"

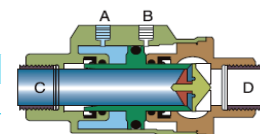

Esquema de funcionamiento

VÁLVULAS MODULARES

VÁLVULA BOLA LATÓN, PASO TOTAL PN 40

CARACTERÍSTICAS:

- Cuerpo en latón niquelado y bola cromada.
- Asiento de teflón.
- Maneta de acero zincado de color rojo.
- -20 a +150°C en ausencia de vapor.
- Opcional bajo pedido, válvulas para aplicación de oxígeno.

- Designación para roscas G:
Rosca BSP cilíndrica, norma DIN 228.
- Designación para roscas R:
Rosca BSP cónica, norma DIN 2999.

Ref.	Código	Rosca H	Presión máx. trabajo (bar)
VBH 04-04	0591105911156	G 1/2"	50
VBH 05-05	0591105911157	G 3/4"	40
VBH 06-06	0591105911158	G 1"	40
VBH 07-07	0591105911159	G 1-1/4"	30
VBH 08-08	0591105911160	G 1-1/2"	30
VBH 09-09	0591105911161	G 2"	25
VBH 10-10	0591105911162	G 2-1/2"	18
VBH 11-11	0591105911163	G 3"	16
VBH 12-12	0591105911164	G 4"	14

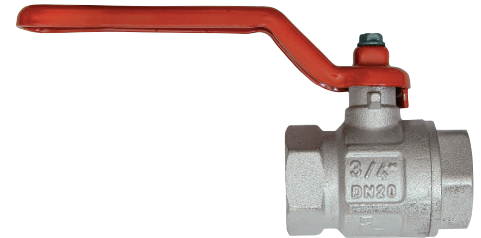

VBH
Válvula bola.

Ref.	Código	D	Conexión	L (mm)	H (mm)	Fig.
JNVF 2005	0404204250020	20	R 3/4" H	92,8	84,7	A
JNVF 2506	0404204250021	25	R 1" H	111,9	88,7	A
JNVF 4008	0404204250022	40	R 1-1/2" H	151,3	114,3	A
JNVF 5009	0404204250023	50	R 2" H	151,3	114,3	A
JNVF 6310	0404204250024	63	JNBRI 63	175	217	B
JNVF 8011	0404204250025	80	JNBRI 80	203	220	B

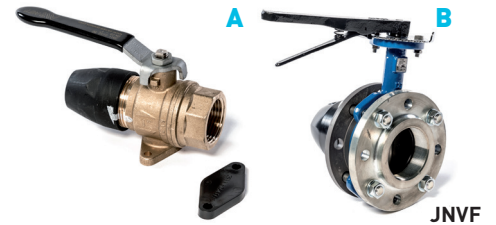

JNVF

Ref.	Código	D	L (mm)	H (mm)	Fig
JNVUC 20	0404204260135	20	92,8	84,7	A
JNVUC 25	0404204260136	25	111,9	88,7	A
JNVUC 40	0404204260137	40	151,3	114,3	A
JNVUC 50	0404204260138	50	151,3	114,3	A
JNVUC 63	0404204260139	63	175	217	B
JNVUC 80	0404204260140	80	203	220	B

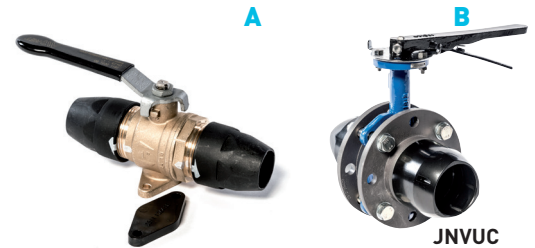

JNVUC

Ref.	Código	Ø Tubo (mm)	L (mm)	W (mm)	BRIDAS NECESARIAS
JNVUC 100	0404204260133	100	52	380	2xJNBRI 100
JNVUC 158	0404204260134	158	62	451	2xJNBRI 158



JNVUC

RECAMBIOS PARA RACORES RÁPIDOS

Ref.	Código
JNRE 2000	0404204260077
JNRE 2500	0404204260078
JNRE 4000	0404204260079
JNRE 5000	0404204260080
JNRE 6300	A CONSULTAR
JNRE 8000	A CONSULTAR



JNRE
Guía, pinza y junta OR.

RACORES ACCESORIOS INOX AISI 316



CARACTERÍSTICAS:

- Estos racores accesorios cumplen la norma ANSI B16.3.
- Calidad Inox 316.
- Presión de trabajo: 20 bar (150 lbs).
- Posibilidad accesorios INOX P.N.130.
- Roscas según normas DIN 259/2999, ANSI B2.1 y BS21-1973.



Gama más amplia en
APARTADO ACCESORIOS,
pág. 364.

Ref.	Código	R	Uds/Embalaje
AXM 01	0707507520150	1/8"	100
AXM 02	0707507520151	1/4"	50
AXM 03	0707507520152	3/8"	50
AXM 04	0707507520153	1/2"	25
AXM 05	0707507520154	3/4"	25
AXM 06	0707507520155	1"	10
AXM 07	0707507520156	1" 1/4"	5
AXM 08	0707507520157	1" 1/2"	5
AXM 09	0707507520158	2"	5
AXM 10	0707507520159	2" 1/2"	5
AXM 11	0707507520160	3"	5



AXM
Manguito Fig.270.

Ref.	Código	R-R	Uds/E.
AXMR 0201	0707507520174	1/4"-1/8"	50
AXMR 0302	0707507520175	3/8"-1/4"	50
AXMR 0402	0707507520176	1/2"-1/4"	50
AXMR 0403	0707507520177	1/2"-3/8"	50
AXMR 0503	0707507520178	3/4"-3/8"	25
AXMR 0504	0707507520179	3/4"-1/2"	25
AXMR 0604	0707507520180	1"-1/2"	10
AXMR 0605	0707507520181	1"-3/4"	10
AXMR 0705	0707507520182	1" 1/4"-3/4"	5
AXMR 0706	0707507520183	1" 1/4"-1"	5
AXMR 0806	0707507520184	1" 1/2"-1"	5
AXMR 0807	0707507520185	1" 1/2"-1" 1/4"	5
AXMR 0907	0707507520186	2"-1" 1/4"	5
AXMR 0908	0707507520187	2"-1" 1/2"	5
AXMR 1008	0707507520188	2" 1/2"-1" 1/2"	5
AXMR 1009	0707507520189	2" 1/2"-2"	5
AXMR 1109	0707507520190	3"-2"	5
AXMR 1110	0707507520191	3"-2" 1/2"	5



AXMR
Manguito reducido
hembra / hembra
Fig.240.

Ref.	Código	R - R	Uds/E.
AXMS 01-01	0707507520192	1 / 8"	100
AXMS 02-02	0707507520193	1 / 4"	50
AXMS 03-03	0707507520195	3 / 8"	50
AXMS 04-04	0707507520197	1 / 2"	25
AXMS 05-05	0707507520198	3 / 4"	25
AXMS 06-06	0707507520199	1"	10
AXMS 07-07	0707507520200	1 1 / 4"	5
AXMS 08-08	0707507520201	1 1 / 2"	5
AXMS 09-09	0707507520202	2"	5
AXMS 10-10	0707507520203	2 1 / 2"	5
AXMS 11-11	0707507520204	3"	5



AXMS
Manguito para soldar.
Fig.270.

Ref.	Código	R-R	Uds/E.
AXC 0101	0707507520002	1/8"-1/8"	100
AXC 0201	0707507520003	1/4"-1/8"	100
AXC 0202	0707507520004	1/4"-1/4"	100
AXC 0302	0707507520005	3/8"-1/4"	100
AXC 0303	0707507520006	3/8"-3/8"	50
AXC 0402	0707507520007	1/2"-1/4"	50
AXC 0403	0707507520008	1/2"-3/8"	50
AXC 0404	0707507520009	1/2"-1/2"	50
AXC 0503	0707507520010	3/4"-3/8"	25
AXC 0504	0707507520011	3/4"-1/2"	25
AXC 0505	0707507520012	3/4"-3/4"	25
AXC 0604	0707507520013	1"-1/2"	10
AXC 0605	0707507520014	1"-3/4"	10
AXC 0606	0707507520015	1"-1"	10
AXC 0706	0707507520017	1" 1/4"-1"	5
AXC 0707	0707507520018	1" 1/4"-1" 1/4"	5
AXC 0806	0707507520019	1" 1/2" - 1"	5
AXC 0807	0707507520020	1" 1/2"-1" 1/4"	5
AXC 0808	0707507520021	1" 1/2"-1" 1/2"	5
AXC 0907	0707507520022	2"-1" 1/4"	5
AXC 0908	0707507520023	2"-1" 1/2"	5
AXC 0909	0707507520024	2"-2"	5
AXC 1008	0707507520025	2" 1/2"-1" 1/2"	5
AXC 1009	0707507520026	2" 1/2" - 2"	5
AXC 1010	0707507520027	2" 1/2"-2" 1/2"	5
AXC 1110	0707507520028	3"-2" 1/2"	5
AXC 1111	0707507520029	3"-3"	5



AXC
Macho cónico
Fig.280.
Macho cónico
reducido Fig.245.

Ref.	Código	R-R	Uds/E.
AXGM 0101	0707507520096	1/8"	25
AXGM 0202	0707507520097	1/4"	25
AXGM 0303	0707507520098	3/8"	20
AXGM 0404	0707507520099	1/2"	10
AXGM 0505	0707507520100	3/4"	10
AXGM 0606	0707507520101	1"	5
AXGM 0707	0707507520102	1"-1/4"	5
AXGM 0808	0707507520103	1"-1/2"	5
AXGM 0909	0707507520104	2"	5
AXGM 1010	0707507520105	2 1/2"	5



AXGM
Manguito 3 piezas
macho / hembra
Fig.341.

Ref.	Código	R-R	Uds/E.
AXG 0101	0707507520085	1/8"	25
AXG 0202	0707507520086	1/4"	25
AXG 0303	0707507520087	3/8"	20
AXG 0404	0707507520088	1/2"	10
AXG 0505	0707507520089	3/4"	10
AXG 0606	0707507520090	1"	5
AXG 0707	0707507520091	1" 1/4"	5
AXG 0808	0707507520092	1" 1/2"	5
AXG 0909	0707507520093	2"	5
AXG 1010	0707507520094	2" 1/2"	5
AXG 1111	0707507520095	3"	5



AXG
Manguito 3 piezas
hembra / hembra
Fig.340.



RACORES ACCESORIOS INOX AISI 316

Ref.	Código	R - R	Uds/Emb.
AXCW 01	0707507520030	1 / 8"	100
AXCW 02	0707507520031	1 / 4"	50
AXCW 03	0707507520032	3 / 8"	50
AXCW 04	0707507520033	1 / 2"	25
AXCW 05	0707507520034	3 / 4"	25
AXCW 06	0707507520035	1"	10
AXCW 07	0707507520036	1 1 / 4"	5
AXCW 08	0707507520037	1 1 / 2"	5
AXCW 09	0707507520038	2"	5
AXCW 10	0707507520039	2 1 / 2"	5
AXCW 11	0707507520040	3"	5



AXCW
Entronque para soldar.
Fig.149.

Ref.	Código	R - R	Uds/Emb.
AXGP 01-01	0707507520106	1 / 8"	25
AXGP 02-02	0707507520107	1 / 4"	25
AXGP 03-03	0707507520108	3 / 8"	20
AXGP 04-04	0707507520109	1 / 2"	10
AXGP 05-05	0707507520110	3 / 4"	10
AXGP 06-06	0707507520111	1"	5
AXGP 07-07	0707507520112	1 1 / 4"	5
AXGP 08-08	0707507520113	1 1 / 2"	5
AXGP 09-09	0707507520114	2"	5
AXGP 10-10	0707507520115	2 1 / 2"	5
AXGP 11-11	0707507520116	3"	5



AXGP
Manguito 3 piezas
H-H.
Asiento plano c/junta
PTFE Fig.330.

Ref.	Código	R-R	Uds/Emb.
AXL 0101	0707507520117	1/8"	50
AXL 0202	0707507520118	1/4"	50
AXL 0303	0707507520119	3/8"	25
AXL 0404	0707507520120	1/2"	25
AXL 0505	0707507520121	3/4"	20
AXL 0606	0707507520122	1"	10
AXL 0707	0707507520123	1" 1/4"	5
AXL 0808	0707507520124	1" 1/2"	5
AXL 0909	0707507520125	2"	5
AXL 1010	0707507520126	2" 1/2"	5
AXL 1111	0707507520127	3"	5



AXL
"L" hembra / hembra
Fig.90.

Ref.	Código	R-R	Uds/Emb.
AXT 0101	0707507520247	1/8"	50
AXT 0202	0707507520248	1/4"	25
AXT 0303	0707507520249	3/8"	25
AXT 0404	0707507520250	1/2"	10
AXT 0505	0707507520251	3/4"	5
AXT 0606	0707507520252	1"	5
AXT 0707	0707507520253	1" 1/4"	5
AXT 0808	0707507520254	1" 1/2"	5
AXT 0909	0707507520255	2"	5
AXT 1010	0707507520256	2" 1/2"	5
AXT 1111	0707507520257	3"	5



AXT
"T" hembra / hembra / hembra
Fig.130.

Ref.	Código	R-R	Uds/E.
AXLM 0101	0707507520139	1/8"	50
AXLM 0202	0707507520140	1/4"	50
AXLM 0303	0707507520141	3/8"	25
AXLM 0404	0707507520142	1/2"	25
AXLM 0505	0707507520143	3/4"	20
AXLM 0606	0707507520144	1"	10
AXLM 0707	0707507520145	1" 1/4"	5
AXLM 0808	0707507520146	1" 1/2"	5
AXLM 0909	0707507520147	2"	5
AXLM 1010	0707507520148	2" 1/2"	5
AXLM 1111	0707507520149	3"	5



AXLM
"L" macho / hembra
Fig.92.

Ref.	Código	R - R	Uds/Emb.
AXZA 01-01	0707507520291	1 / 8"	50
AXZA 02-02	0707507520292	1 / 4"	25
AXZA 03-03	0707507520293	3 / 8"	15
AXZA 04-04	0707507520294	1 / 2"	10
AXZA 05-05	0707507520295	3 / 4"	5
AXZA 06-06	0707507520296	1"	5
AXZA 07-07	0707507520297	1 1 / 4"	5
AXZA 08-08	0707507520298	1 1 / 2"	5
AXZA 09-09	0707507520299	2"	5
AXZA 10-10	0707507520300	2" 1/2"	5
AXZA 11-11	0707507520301	3"	5



AXZA
Cruz
Fig.180.

Ref.	Código	R-R	Uds/E.
AXLC 0101	0707507520128	1/8"	50
AXLC 0202	0707507520129	1/4"	50
AXLC 0303	0707507520130	3/8"	50
AXLC 0404	0707507520131	1/2"	25
AXLC 0505	0707507520132	3/4"	20
AXLC 0606	0707507520133	1"	10
AXLC 0707	0707507520134	1" 1/4"	5
AXLC 0808	0707507520135	1" 1/2"	5
AXLC 0909	0707507520136	2"	5
AXLC 1010	0707507520137	2" 1/2"	5
AXLC 1111	0707507520138	3"	5



AXLC
Codo 45°, hembra / hembra
Fig.120.

Ref.	Código	R - R	Uds/E.
AXY 01-01	0707507520280	1 / 8"	50
AXY 02-02	0707507520281	1 / 4"	50
AXY 03-03	0707507520282	3 / 8"	25
AXY 04-04	0707507520283	1 / 2"	20
AXY 05-05	0707507520284	3 / 4"	15
AXY 06-06	0707507520285	1"	10
AXY 07-07	0707507520286	1 1 / 4"	5
AXY 08-08	0707507520287	1 1 / 2"	5
AXY 09-09	0707507520288	2"	5
AXY 10-10	0707507520289	2" 1/2"	5
AXY 11-11	0707507520290	3"	5



AXY
"Y" h / h / h.

RACORES ACCESORIOS INOX AISI 316



Ref.	Código	Ø int.	Uds/E.
mang. - R			
AXEAC 0601	0707507520041	6 - R1/8"	100
AXEAC 0602	0707507520042	6 - R1/4"	100
AXEAC 0801	0707507520044	8 - R1/8"	100
AXEAC 0802	0707507520045	8 - R1/4"	100
AXEAC 1002	0707507520047	10 - R1/4"	100
AXEAC 1003	0707507520048	10 - R3/8"	100
AXEAC 1004	0707507520049	10 - R1/2"	-
AXEAC 1203	0707507520051	12 - R3/8"	50
AXEAC 1204	0707507520053	12 - R1/2"	50
AXEAC 1402	0707507520054	14 - R1/4"	50
AXEAC 1403	0707507520055	14 - R3/8"	50
AXEAC 1504	0707507520056	15 - R1/2"	50
AXEAC 1604	0707507520057	16 - R1/2"	50
AXEAC 1904	0707507520058	19 - R1/2"	25
AXEAC 1905	0707507520059	19 - R3/4"	-
AXEAC 2005	0707507520060	20 - R3/4"	25
AXEAC 2505	0707507520061	25 - R3/4"	20
AXEAC 2506	0707507520062	25 - R1"	-
AXEAC 2706	0707507520063	27 - R1"	20
AXEAC 3006	0707507520064	30 - R1"	15
AXEAC 3007	0707507520065	30 - R1"1/4"	15
AXEAC 3407	0707507520068	34 - R1"1/4"	10
AXEAC 3808	0707507520069	38 - R1-1/2"	-
AXEAC 4008	0707507520070	40 - R1"1/2"	5
AXEAC 5008	0707507520071	50 - R1"1/2"	5
AXEAC 5009	0707507520072	50 - R2"	5
AXEAC 5209	0707507520073	52 - R2"	5
AXEAC 6009	0707507520074	60 - R2"	5
AXEAC 6310	0707507520075	63 - R2"1/2"	5



AXEAC
Macho con espiga manguera
y rosca cónica Fig.399.

Ref.	Código	Ø int.	Uds/E.
mang. - R			
AXEB 0601	0707507520077	6 - G1/8"	-
AXEB 0602	0707507520078	6 - G1/4"	-
AXEB 0603	0707507520079	6 - G3/8"	-
AXEB 0802	0707507520080	8 - G1/4"	-
AXEB 0803	0707507520081	8 - G3/8"	-
AXEB 1002	0707507520082	10 - G1/4"	-
AXEB 1003	0707507520083	10 - G3/8"	-
AXEB 1204	0707507520084	12 - G1/2"	-



AXEB
Hembra con espiga manguera.

Ref.	Código	R - R	Uds/E.
AXMC 01	0707507520161	1 /8"	100
AXMC 02	0707507520162	1 /4"	100
AXMC 03	0707507520163	3 /8"	100
AXMC 04	0707507520164	1 /2"	50
AXMC 05	0707507520165	3 /4"	25
AXMC 06	0707507520166	1"	25
AXMC 07	0707507520167	1 1/4"	10
AXMC 08	0707507520168	1 1/2"	10
AXMC 09	0707507520170	2"	10
AXMC 10	0707507520171	2"1/2"	10
AXMC 11	0707507520172	3"	10



AXMC
Tuerca
Fig.312.

Ref.	Código	R-R	Uds/E.
AXR 0201	0707507520215	M1/4"-H1/8"	100
AXR 0301	0707507520216	M3/8"-H1/8"	50
AXR 0302	0707507520217	M3/8"-H1/4"	50
AXR 0402	0707507520218	M1/2"-H1/4"	25
AXR 0403	0707507520219	M1/2"-H3/8"	25
AXR 0503	0707507520220	M3/4"-H3/8"	25
AXR 0504	0707507520221	M3/4"-H1/2"	25
AXR 0604	0707507520222	M1"-H1/2"	10
AXR 0605	0707507520223	M1"-H3/4"	10
AXR 0705	0707507520225	M1"1/4"-H3/4"	5
AXR 0706	0707507520226	M1"1/4"-H1"	5
AXR 0806	0707507520227	M1"1/2"-H1"	5
AXR 0807	0707507520228	M1"1/2"-H1" 1/4"	5
AXR 0907	0707507520229	M2"-H1"1/4"	5
AXR 0908	0707507520230	M2 "-H1"1/2"	5
AXR 1008	0707507520231	M2"1/2"-H1"1/2"	5
AXR 1009	0707507520232	M2"1/2"-H2"	5
AXR 1109	0707507520233	M3"-H2"	5
AXR 1110	0707507520234	M3"-H2"1/2"	5



AXR
Reducción cónica macho /
cilíndrica hembra Fig.241.

Ref.	Código	R-R	Uds/E.
AXQ 0102	0707507520205	M1/8"-H1/4"	25
AXQ 0203	0707507520206	M1/4"-H3/8"	25
AXQ 0304	0707507520207	M3/8"-H1/2"	20
AXQ 0405	0707507520208	M1/2"-H3/4"	20
AXQ 0506	0707507520209	M3/4"-H1"	10
AXQ 0507	0707507520210	M3/4"-1"1/4"	5
AXQ 0607	0707507520212	M1"-H1"1/4"	5
AXQ 0508	0707507520211	M3/4"-H1"1/2"	5
AXQ 0608	0707507520213	M1"-H1"1/2"	5
AXQ 0708	0707507520214	M1"1/4"-H1"1/2"	5



AXQ
Cónico macho / hembra
cilíndrica Fig.246.

Ref.	Código	R	Uds/E.
AXV 0100	0707507520258	1/8"	100
AXV 0200	0707507520259	1/4"	100
AXV 0300	0707507520260	3/8"	50
AXV 0400	0707507520261	1/2"	50
AXV 0500	0707507520262	3/4"	50
AXV 0600	0707507520263	1"	25
AXV 0700	0707507520264	1"1/4"	10
AXV 0800	0707507520265	1"1/2"	10
AXV 0900	0707507520266	2"	10
AXV 1010	0707507520267	2"1/2"	10
AXV 1111	0707507520268	3"	5



AXV
Tapón cónico
Fig.290.

Ref.	Código	R	Uds/E.
AXVF 0100	0707507520269	1/8"	50
AXVF 0200	0707507520270	1/4"	50
AXVF 0300	0707507520271	3/8"	50
AXVF 0400	0707507520272	1/2"	50
AXVF 0500	0707507520273	3/4"	25
AXVF 0600	0707507520274	1"	25
AXVF 0700	0707507520275	1"1/4"	10
AXVF 0800	0707507520276	1"1/2"	10
AXVF 0900	0707507520277	2"	10
AXVF 1010	0707507520278	2" 1/2"	10
AXVF 1111	0707507520279	3"	5



AXVF
Tapón hembra
Fig.300.

RACORES 3 PIEZAS EN LATÓN NIQUELADO

Ref.	Código	Rosca
AQGL 0404	0202102110160	G 1/2"
AQGL 0505	0202102110161	G 3/4"
AQGL 0606	0202102110162	G 1"
AQGL 0707	0202102110163	G 1 1/4"



AQGL

DISTRIBUIDORES APLIQUE MURAL

CARACTERÍSTICAS:

. Temperatura de trabajo: -25°C a +80°C.

VERSIÓN TUBO - TRIPLE Y SIMPLE SALIDA

Ref.	Código	Entrada	Utilización
INDT 120204	0404204230013	20	3 x G 1/2"
INDT 125204	0404204230015	25	3 x G 1/2"
INDT 120104	0404204230012	20	1 x G 1/2"
INDT 125104	0404204230014	25	1 x G 1/2"



INDT

Salida inferior con purga manual incluida.



VERSIÓN VÁLVULA - TRIPLE SALIDA

Ref.	Código	Entrada	Utilización
INDV 104204	0404204230016	G 1/2"	3 x G 1/2"
INDV 105204	0404204230017	G 3/4"	3 x G 1/2"
INDV 106204	0404204230018	G 1"	3 x G 1/2"

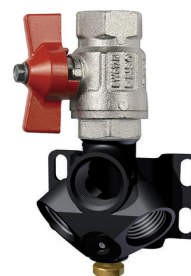

INDV

Salida inferior con purga manual incluida.

VERSIÓN ROSCA - TRIPLE SALIDA

Ref.	Código	Entrada	Utilización
INDP 104204	0404204230010	G-1/2"	3 x G 1/2"
INDP 105204	0404204230011	G-3/4"	3 x G 1/2"



INDP

Salida inferior con purga manual incluida.

Ref.	Código	Entrada	Utilización
IDE 104103	0404204230002	1/2"	1 x 3/8"
IDE 104203	0404204230003	1/2"	2 x 3/8"
IDE 204103	0404204230004	1 x 3/8"	2 x 1/2"



IDE

Cuerpo de color negro. Tuberías hasta Ø 20mm.

Ref.	Código	Entrada/salida	Utilización
INDC 220604	0404204230008	Tubo Ø20	6 x 1/2"
INDC 225604	0404204230009	Tubo Ø25	6 x 1/2"



INDC

Distribuidor - colector

DISTRIBUIDORES APLIQUE MURAL MÚLTIPLE



BASE

Racores base con conectores enchufables integrados para conectarse fácilmente la tubería.

CARACTERÍSTICAS:

- Para el montaje a la pared o techo.
- Incluye la pantalla extraíble que puede utilizarse como plantilla de perforación.
- Presión máx. de funcionamiento: 16 bar a -20°C a $\leq +50^{\circ}\text{C}$.

Modelo	Ref.	Código	Entrada	Utilización	Medidas (mm)
1	INDM 104104	A CONSULTAR	1 x 1/2"	1 x 1/2"	82 x 85 x 45
2	INDM 104204	A CONSULTAR	1 x 1/2"	2 x 1/2"	83 x 85 x 45
3	INDM 104304	A CONSULTAR	1 x 1/2"	3 x 1/2"	84 x 85 x 45
4	INDM 104504	A CONSULTAR	trasera 1 x 1/2"	5 x 1/2"	85 x 85 x 45
5	INDM 105305	A CONSULTAR	1 x 1/2"	3 x 3/4" + 1 x 1/2"	90 x 90 x 53

TAPA

Exclusivamente para adaptar un racor base.

CARACTERÍSTICAS:

- Tapa que incluye el material de fijación y sellado.
- Presión máx. de funcionamiento: 16 bar a -20°C a $\leq +50^{\circ}\text{C}$.

Modelo	Ref.	Código	Entrada	Utilización
A	INDM 0204	A CONSULTAR	trasera 1 x 1/2"	2 x 1/2"
B	INDM 0304	A CONSULTAR	trasera 1 x 1/2"	3 x 1/2"
C	INDM 0404	A CONSULTAR	trasera 1 x 1/2"	4 x 1/2"
D	Tapa incluida en todas las bases			



* Es necesario un racor base.

CUADRO DE COMBINACIÓN DE LOS MODELOS, CUALQUIER BASE CON CUALQUIER TAPA:

BASES



TAPAS





EJEMPLO DE BAJANTE

Gran versatilidad para instalación de bajantes en función de los requerimientos del cliente.



AR NET

HERRAMIENTAS DE MONTAJE



JNHBRO
Corona / broca.

Ref.	Código	Ø tubo
JNHBRO 13	0404204250006	hasta 25
JNHBRO 18	0404204250007	a partir de 40



Ref.	Código	JNHSBRO
JNHSBRO	0404204250019	porta brocas.



JNHCOR
Cortatubo.

Ref.	Código	Ø tubo
JNHCOR 63	0404204250013	20-63
JNHCOR 100	0404204250012	40-100



JNHCAF
Herramienta chaflanar.

Ref.	Código	Ø tubo
JNHCAF 50	0404204250009	hasta 50 mm
JNHCAF 63	0404204250010	63
JNHCAF 80	0404204250011	80



Ref.	Código	JNHDES
JNHDES	0404204250014	Herramienta desbarbar.



Ref.	Código	JNHPR
JNHPR	0404204250018	Galga para inserción de racores.

Ref.	Código	Ø tubo
JNNHAPR 20	0404204260066	20
JNNHAPR 25	0404204260067	25
JNNHAPR 40	0404204260068	40
JNNHAPR 50	0404204260069	50
JNHAPR 63	A CONSULTAR	63
JNHAPR 80	A CONSULTAR	80



JNHAPR
Llave apriete.

Ref.	Código
JNHLU	0404204250015



JNHLU
Lubricante montaje.

COMPLEMENTOS SOPORTACIÓN **AIRNET**

CARACTERÍSTICAS:

. Siguiendo el principio de sistemas modulares, los complementos de soporte AIRNET facilitan la realización de las instalaciones.



Ref.	Código	R
JNCLIP 20	0404204270036	M6
JNCLIP 25	0404204270037	
JNCLIP 40	0404204270038	
JNCLIP 50	0404204270039	
JNCLIP 63	0404204270040	M8
JNCLIP 80	0404204270041	
JNCLIP 100	A CONSULTAR	
JNCLIP 158	A CONSULTAR	



JNCLIP
Diseño más robusto.
Amplia superficie apoyo tubo.
Con tuerca M6 integrada.

Ref.	Código	R
JABR 16	0404204270012	M8
JABR 20	0404204270013	M8
JABR 25	0404204270014	M8
JABR 40	0404204270016	M8
JABR 50	0404204270017	M8/10
JABR 63	0404204270018	M8/10
JABR 80	0404204270019	M8/10
JABR 100	0404204270009	M8/10
JABR 158	0404204270011	M8/10



JABR
Para tornillo M8/M10.

Ref.	Código	Ø tubo
JNDISPE 25	0404204270044	20 - 25
JNDISPE 50	0404204270046	40 - 50
JNDISPE 80	0404204270047	63 - 80
JNDISPE 100	0404204270042	100



JNDISPE
Distanciador.

Ref.	Código	Rosca
JHUSM	0404204270030	M10
JHUSF	0404204270029	M8/10



JHUSM



JHUSF

Ref.	Código	L
JGUIA 2718	0404204270027	2 m
JGUIA 2830	0404204270028	2 m

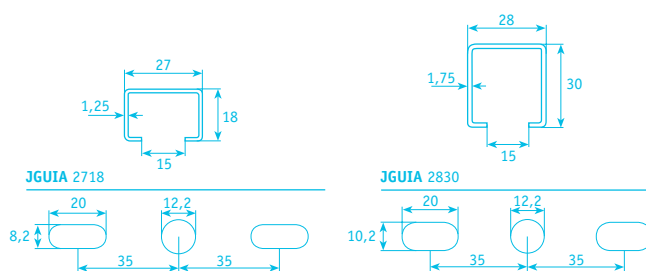

JGUIA
Guía perforada galvanizada.

Ref.	Código	mm
JTLL0 M650	0404204270064	M6 x 50
JTLL0 M850	0404204270066	M8 x 50
JTLL0 M860	0404204270067	M8 x 60
JTLL0 M890	0404204270069	M8 x 90
JTLL0 M8120	0404204270065	M8 x 120



JTLL0
Tornillo.

Ref.	Código	L (mm)
JSH 100	0404204270056	145
JSH 150	0404204270057	195
JSH 200	0404204270058	245
JSH 300	0404204270059	345

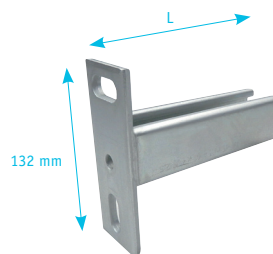

JSH
Soporte horizontal a pared.

Ref.	Código
JMOR 19M8	0404204270033



JMOR
Mordaza.

Ref.	Código
JTGUIA M830	0404204270063



JTGUIA
Tornillo para guía perforada.

Ref.	Código	Montaje
JSOPVERT	0404204270061	vertical
JSOPHORIZ	0404204270060	horizontal



JSOP
Soporte para guía perforada.

Ref.	Código	Rosca	L
JESP M620		M6	20 mm
JESP M820		M8	25 mm
JESP M830		M8	30 mm
JESP M1030		M10	30 mm



JESP
Espiga separador.

Ref.	Código
JTAPGUIA 2718	0404204270062



JTAPGUIA
Tapón para guía perforada.

Ref.	Código
JMAN M8 X20	0404204270031
JMAN M8 X30	0404204270032



JMAN
Manguito separador.

Ref.	Código
JTUE M6	A CONSULTAR
JTUE M8	0404204270070
JTUE M10	A CONSULTAR



JTUE
Tuerca.

UNIDAD DE TRATAMIENTO DE AIRE COMPRIMIDO



SELECCIÓN RÁPIDA

FILTRO serie EF/EIF

Ref.	Rosca	Caudal l/min. (7,1 bar entrada)
EIF 2000-01	G1/8	1222
EIF 2000-02	G1/4	1278
EIF 3000-02	G1/4	2006
EIF 3000-03	G3/8	2148
EIF 4000-03	G3/8	5120
EIF 4000-04	G1/2	5430
EIF 5000-06	G3/4	8200
EIF 5000-10	G1	8500



EIF 2000



EIF 3000/4000/5000

LUBRICADOR serie EL/EIL

Ref.	Rosca	Caudal l/min. (7,1 bar entrada)
EIL 2000-01	G1/8	1300
EIL 2000-02	G1/4	1345
EIL 3000-02	G1/4	2310
EIL 3000-03	G3/8	2375
EIL 4000-03	G3/8	5321
EIL 4000-04	G1/2	5532
EIL 5000-06	G3/4	7700
EIL 5000-10	G1	8000



EIL 2000



EIL 3000/4000/5000

REGULADOR serie ER/EIR

Ref.	Rosca	Caudal l/min. (7,1 bar entrada)
ER/EIR 2000-01	G1/8	1178
ER/EIR 2000-02	G1/4	1200
ER/EIR 3000-02	G1/4	2112
ER/EIR 3000-03	G3/8	2212
ER/EIR 4000-03	G3/8	5020
ER/EIR 4000-04	G1/2	5312
ER/EIR 5000-06	G3/4	6400
ER/EIR 5000-10	G1	6600



ER



EIR

* La información se basa en la presión de suministro de 8,0 bar y la presión de ajuste de 6,3 bar.

. EIR para opción con manómetro integrado. Opción filtraje 5 micras, especificando 5μ al final de la referencia. Opción de purga automática.

. Soportes de montaje incluidos en el suministro.

FILTRO - REGULADOR serie EW/EIW

Ref.	Rosca	Caudal l/min. (7,1 bar entrada)
EW/EIW 2000-01	G1/8	1078
EW/EIW 2000-02	G1/4	1165
EW/EIW 3000-02	G1/4	1998
EW/EIW 3000-03	G3/8	2177
EW/EIW 4000-03	G3/8	5108
EW/EIW 4000-04	G1/2	5211
EW/EIW 5000-06	G3/4	6200
EW/EIW 5000-10	G1	6400



EW



EIW

. Soporte de montaje incluido en el suministro.

FILTRO - REGULADOR - LUBRICADOR COMPACTO serie EC/EIC

Ref.	Rosca	Caudal l/min. (7,1 bar entrada)
EC/EIC 2010-01	G1/8	945
EC/EIC 2010-02	G1/4	960
EC/EIC 3010-02	G1/4	1874
EC/EIC 3010-03	G3/8	1956
EC/EIC 4010-03	G3/8	4923
EC/EIC 4010-04	G1/2	5120
EC/EIC 5010-06	G3/4	6000
EC/EIC 5010-10	G1	6200



FILTRO - REGULADOR - LUBRICADOR EN LÍNEA serie EC/EIC

Ref.	Rosca	Caudal l/min. (7,1 bar entrada)
EC/EIC 2000-01	G1/8	1000
EC/EIC 2000-02	G1/4	1100
EC/EIC 3000-02	G1/4	1950
EC/EIC 3000-03	G3/8	2150
EC/EIC 4000-03	G3/8	4950
EC/EIC 4000-04	G1/2	5200
EC/EIC 5000-06	G3/4	6200
EC/EIC 5000-10	G1	6500



DERIVACIÓN PARA SERIE EI

Ref.	Código
NEUB240	0303403410011
NEUB340	0303403410012
NEUB440	0303403410013
NEUB540	0303403410014
NEUB640	0303403410015



SOPORTES

Ref.	Código	Para modelo
NEUY2102	0303403410328	EIF / EIL 2000
NEUY3102	0303403410331	EIF / EIL 3000
NEUY4103	0303403410334	EIF / EIL 4000
NEUY6104	0303403410339	EIF / EIL 4000-06



PURGA ELECTRÓNICA TEMPORIZADA

Ref.	Código	Voltaje
VAET 0202	0404204220031	220VAC
VAET 020224	0404204220032	24VAC



VAET
Electroválvula 1/2" BSP Acción directa.
Paso interno: 4 mm.
Presión de trabajo: 0 - 16 bar.
Cuerpo latón con junta VITÓN (FKM).
Presión de servicio: 20 bar.
Filtro integrado.

BOTE ACEITE PARA LUBRICADORES

Ref.	Código	Tipo
GOIL	0303403410143	bidón 1l



También disponemos de manómetros secos y manómetros con glicerina.

CONSULTE EN NUESTRO APARTADO DE GRUPOS DE FILTRAJE, PÁG. 635-638

